

# Scaleauto

Model Car Competition

# 2012

1/32 • 1/24 Race Tuned Slot Competition Cars



# Audi R8 LMS NEW

**SC-7043**  
**24h Nürburgring 2009 #98**  
Team Phoenix Racing



**SC-7045**  
**ADAC Ruhr-Pokal-Rennen 2009 #80**  
Team Phoenix Racing

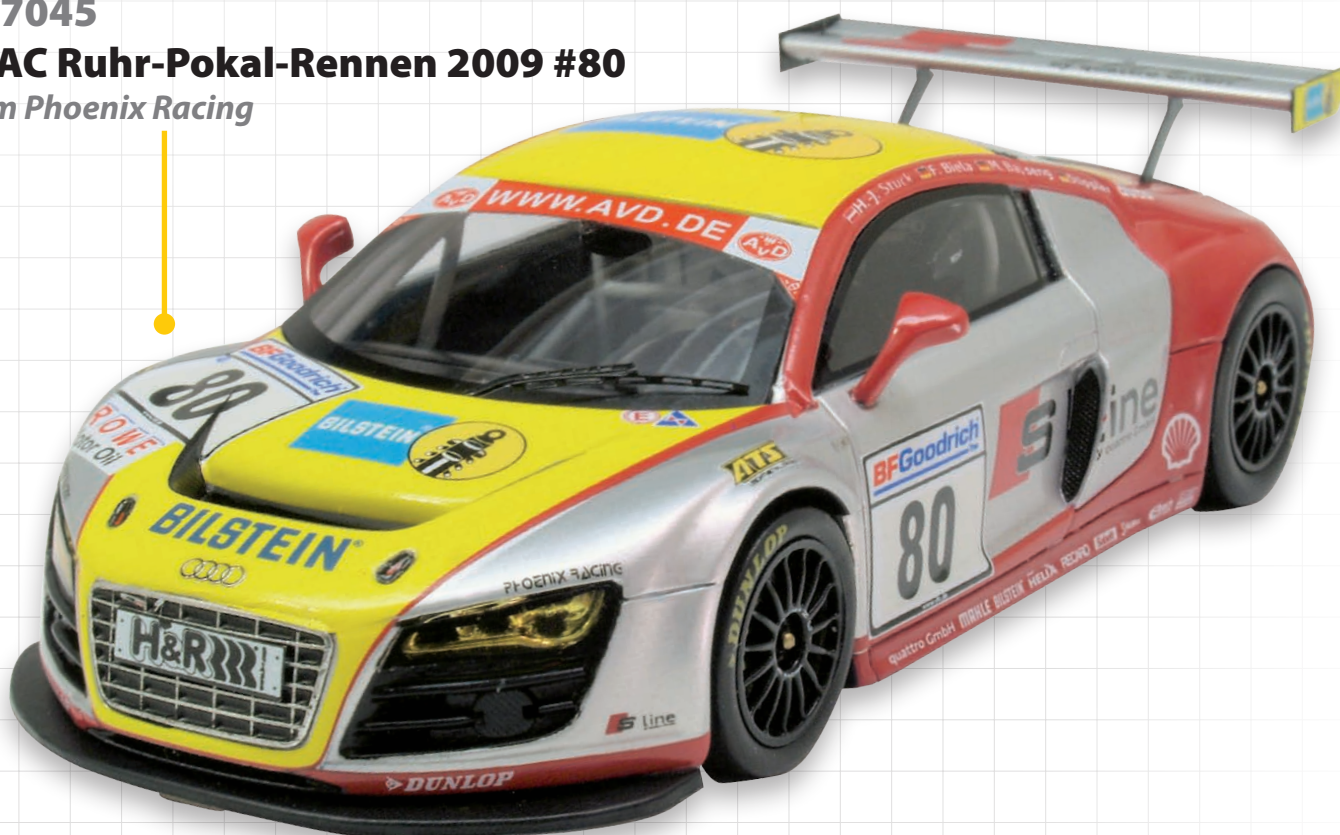

	Reference	Motor	Motor Size	Guide	Ratio	Chassis		Front		Rear	
								ø Tire	Hub	ø Tire	Hub
24h Nürburgring 2009 #98	SC-7043							26 x 10	23,5 x 10	27 x 13	23,5 x 13
ADAC Ruhr-Pokal-Rennen 2009 #80	SC-7045	SC-25		SC-1622	12/44	SC-8000	YES	Hard	Aluminium	Soft	Aluminium
White body racing kit	SC-7044		Long Can								

**Ready Painted Bodies**  
SC-7053b 24h Nürburgring 2010 #49

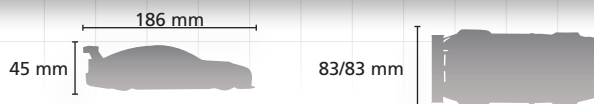

• NEW • **BMW Z4 GT3**

**SC-7030**  
**SuperGT 2011 #4**  
*Studie AG*



**SC-7032b**  
**24h Barcelona 2011 #2**  
*Schubert Motorsport*



	Reference	Motor	Motor Size	Guide	Ratio	Chassis		Front		Rear	
								ø Tire	Hub	ø Tire	Hub
SuperGT 2011 #4 Studie AG	SC-7030	SC-25		SC-1622	12/44	SC-8000	YES	26 x 10	23,5 x 10	27 x 13	23,5 x 13
White body racing kit	SC-7031							Hard	Aluminium	Soft	Aluminium

Ready Painted Bodies  
SC-7032b | 24h Barcelona 2011 #2

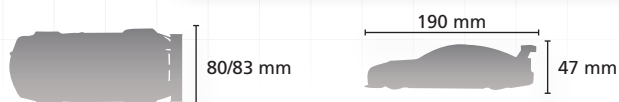

# BMW M3 GT2

SC-7035 • NEW •

24h Le Mans 2011 #55



SC-7037b • NEW •

ALMS 2010 #90



SC-7015

24h Le Mans 2010 #78



• NEW • SC-7022

24 h Nürburgring 2010 #25



Reference	Motor	Motor Size	Guide	Ratio	Chassis	BB SERIES	Front		Rear	
							ø Tire	Hub	ø Tire	Hub
24h Le Mans 2010 #78	SC-7015	SC-25 Long Can	SC-1601	12/44	SC-8000	YES	26 x 10 Hard	23,5 x 10 Aluminium	27 x 13 Soft	23,5 x 13 Aluminium
24h Nürburgring 2010 #25	SC-7022									
24h Le Mans 2011 #55	SC-7035									
White body racing kit	SC-7009									

Ready Painted Bodies

- SC-7008b 12h Sebring ALMS 2009 #92
- SC-7015b 24h Le Mans 2010 #78
- SC-7036b 24h Le Mans 2011 #56
- SC-7037b ALMS 2010 #90



# Mercedes Benz SLS AMG GT3



SC-7027

24h Nürburgring 2011 #3

Black Falcon

• NEW •



• NEW • SC-7024

IberGT Jarama 2011 #23



Vodafone BP Ultimate Team

SC-7026b • NEW •

24h Nürburgring 2011 #22

Black Falcon



Reference	Motor	Motor Size	Guide	Ratio	Chassis		Front		Rear	
							ø Tire	Hub	ø Tire	Hub
24h Nürburgring 2010 #738	SC-7021	 Long Can	SC-1622	12/44	SC-8000	YES	26 x 10 Hard	23,5 x 10 Aluminium	27 x 13 Soft	23,5 x 13 Aluminium
IberGT Jarama 2011 #23	SC-7024									
24h Nürburgring 2011 #3	SC-7027									
White body racing kit	SC-7020									

Ready Painted Bodies

SC-7025b 24h Nürburgring 2010 #739 Mamerow Racing

SC-7026b 24h Nürburgring 2011 #22 Black Falcon

SC-7028b ADAC GT Master 2011 #32 Gize SLS Team

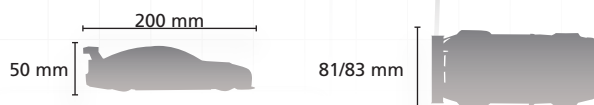

# Jaguar XKR GT2

SC-7018

Petit Le Mans 2010 #33

RSR





SC-7023 • NEW •

Le Mans 2010 #81

RSR



	Reference	Motor	Motor Size	Guide	Ratio	Chassis		Front		Rear	
								ø Tire	Hub	ø Tire	Hub
Petit Le Mans 2010 #33	SC-7018										
24h Le Mans 2010 #81	SC-7023	SC-25		SC-1601	12/44	SC-8000	YES	26 x 10 Hard	23,5 x 10 Aluminium	27 x 13 Soft	23,5 x 13 Aluminium
White body racing kit	SC-7019		Long Can								

Ready Painted Bodies

SC-7029b 12h Sebring ALMS 2011 #99



# Porsche 911 RSR

SC-7011

**Team Martini #95**

JWA Racing

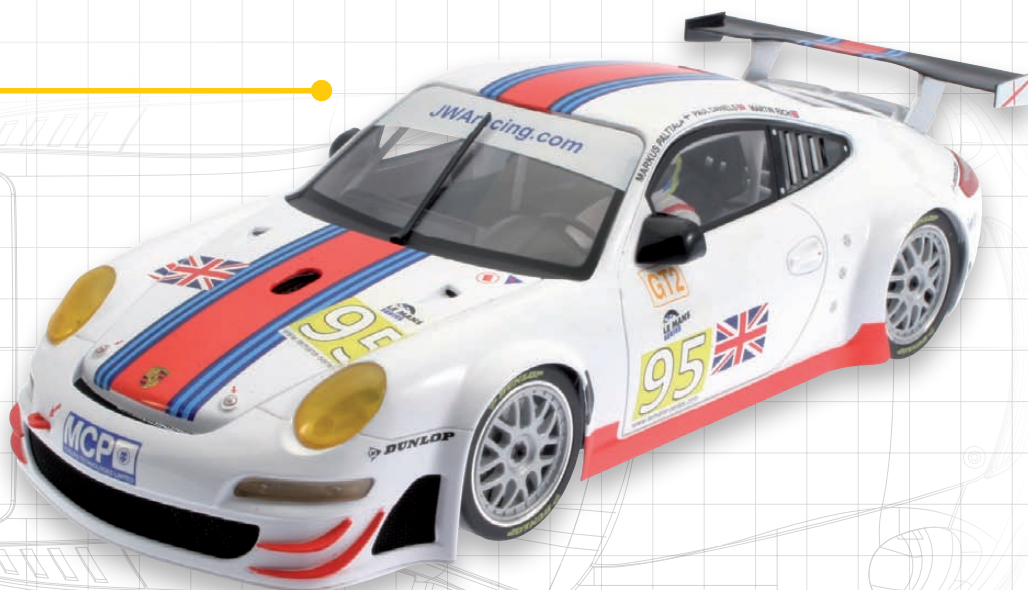

**SC-7040 • NEW •**

**SuperGT 2011 #33**

Team Hankook KTR

**• NEW • SC-7041**

**24h Nürburgring 2011 #18**

Manthey Racing



**SC-7050b • NEW •**

**VLN'2010 #10**

Manthey Racing



Reference	Motor	Motor Size	Guide	Ratio	Chassis		Front		Rear	
							ø Tire	Hub	ø Tire	Hub
Team Martini JWA #95	SC-7011									
Team Felbermayr LM 2010	SC-7016									
SuperGT 2011 #33	SC-7040	SC-25				YES	26 x 10 Hard	23,5 x 10 Aluminium	27 x 13 Soft	23,5 x 13 Aluminium
24h Nürburgring 2011 #18	SC-7041									
White body racing kit	SC-7005									



Long Can

Ready Painted Bodies

SC-7038b Le Mans 2011 #80 Flying Lizard

SC-7039b Le Mans 2011 #81 Flying Lizard

SC-7049b SuperGT 2011 #25 Zent

SC-7050b VLN'2010 #10 Manthey Racing

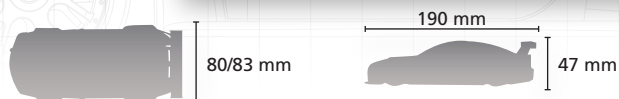

# Porsche 911 GT3

SC-7014

IMSA Michelin GT3 Cup #96

Kelly Moss Racing



• NEW • SC-7033

IMSA 2011 GT3 Cup

Road Atlanta #24

NGT Motorsport



SC-7010

24h Nürburgring 2009 #18

Monster FM



SC-7013 • NEW •

IMSA GT3 Challenge 2008 #97

Kelly Moss Racing



# Porsche 911 GT3 Rally

SC-7012

Rally Villajoiosa 2009 #3

Fuster



SC-7047b • **NEW** •

Rally Ferrol 2009 #5

Mex Machado



	Reference	Motor	Motor Size	Guide	Ratio	Chassis		Front		Rear	
								ø Tire	Hub	ø Tire	Hub
24h Nürburgring 2009 #18	SC-7010	SC-25		SC-1601	12/44	SC-8000	YES	26 x 10 Hard	23,5 x 10 Aluminium	27 x 13 Soft	23,5 x 13 Aluminium
Rally Villajoiosa 2009 #3	SC-7012			SC-1605							
GT3 Challenge 2008 #97	SC-7013			SC-1601							
IMSA Michelin GT3 Cup #96	SC-7014			SC-1601							
IMSA 2011 GT3 Cup Road Atlanta #24	SC-7033			SC-1601							
White body racing kit	SC-7004			SC-1605							

Ready Painted Bodies

- SC-7014b Cup Gulf Moss Racing Michelin GT3 Cup
- SC-7047b Rally Ferrol 2009 #5 Mex Machado

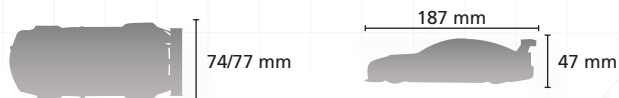

SC-1605 - SC-1601

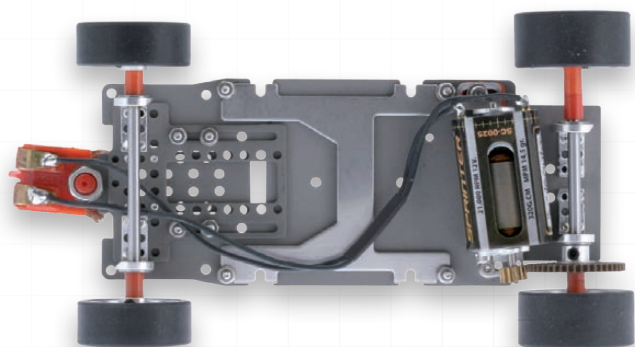

**SC-8000RTR**  
Complete SC-8000 chassis assembled  
Fixed guide

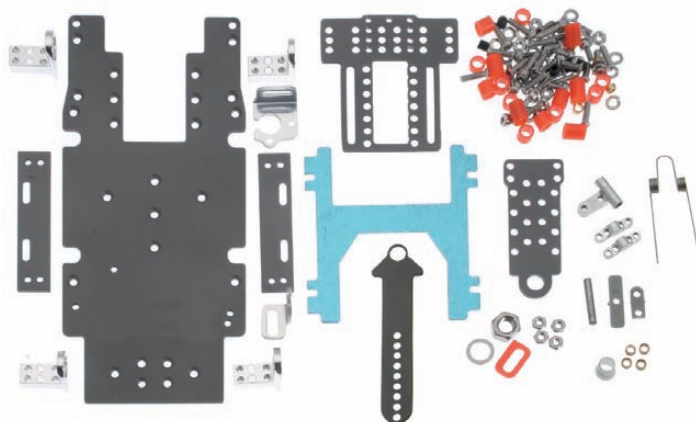

**SC-8000b**  
Complete chassis kit

**Body Kits and Body Spare Pieces**

Reference	Body kits
SC-7501	Porsche 911 RSR (997 model)
SC-7502	Porsche 911 GT3 (997 model) Cup & Rally
SC-7503	BMW M3 GT2
SC-7504	Jaguar XKR GT2 <b>• NEW •</b>
SC-7505	Mercedes SLS AMG GT3 <b>• NEW •</b>
SC-7506	Audi R8 LMS <b>• NEW •</b>
SC-7507	BMW Z4 GT3 <b>• NEW •</b>

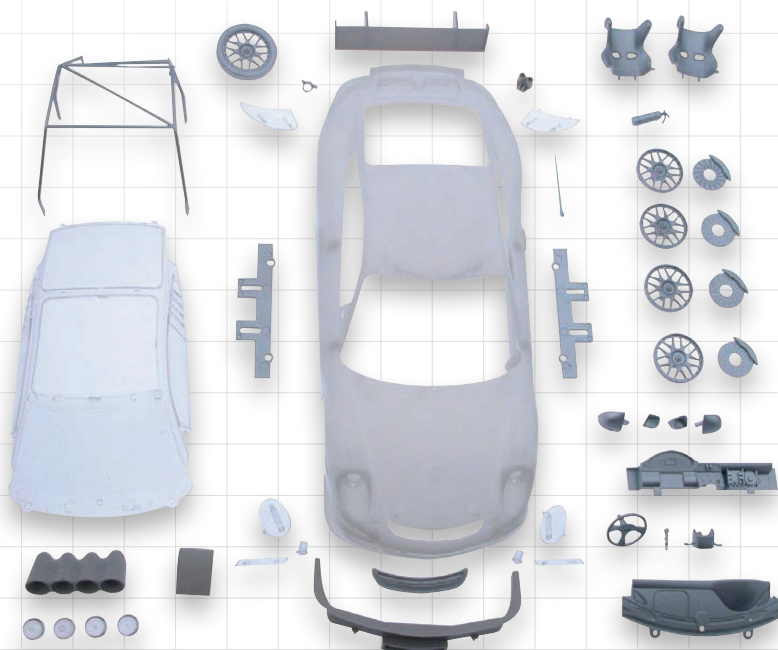

Reference	Body spare pieces
SC-7611	Porsche 911 GT3 (997 model) Cup & Rally
SC-7612	BMW M3 GT2
SC-7613	Jaguar XKR GT2 <b>• NEW •</b>
SC-7614	Mercedes SLS AMG GT3 <b>• NEW •</b>
SC-7616	Audi R8 LMS <b>• NEW •</b>
SC-7617	BMW Z4 GT3 <b>• NEW •</b>

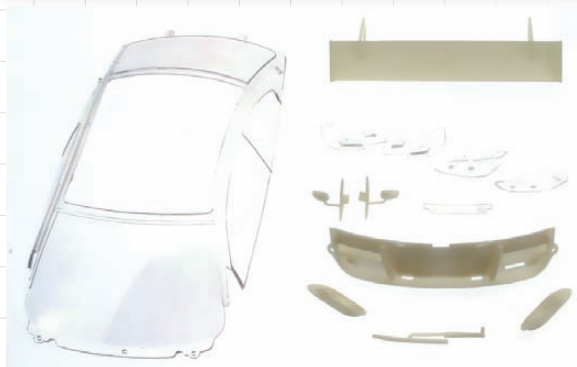

**Carbon Performance Kit**

**• NEW •**

Lightweight kit	Rear wing (Rubber + Carbon fiber)	
SC-7901	SC-7901b	Porsche 911 GT3 RSR
SC-7902	SC-7902b	BMW M3 GT2
SC-7903	SC-7903b	Jaguar XKR GT2
SC-7904	SC-7904b	Mercedes SLS AMG GT3
SC-7905	SC-7905b	Audi R8 LMS
SC-7906	SC-7906b	BMW Z4 GT3



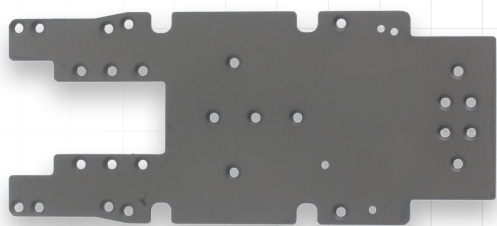

**SC-8100**  
Chassis main plate.



**SC-7604**  
Modern RALLY complete cockpit.  
**SC-7605**  
Modern GT complete cockpit.

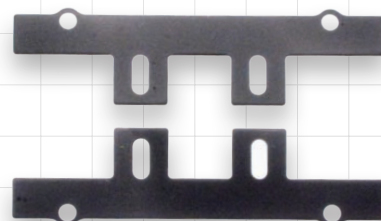

Reference	Metal body mount
SC-8117	Porsche 911
SC-8119	BMW M3, Jaguar XKR, Mercedes SLS
SC-8124	Audi R8 GT3 <b>NEW</b>
SC-8125	BMW Z4 GT3 <b>NEW</b>



**SC-8121**  
Rear axle mount self adjustable.

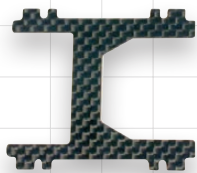

**SC-8101**  
H Plate (steel)  
**SC-8101c**  
H Plate (carbon fiber)



**SC-8102c**  
H Plate Pro (carbon fiber)

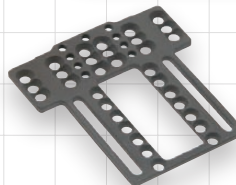

**SC-8103**  
Front axle subframe (steel)



**SC-8104**  
Fix Guide holder (steel)  
**SC-8104c**  
Fix steel guide holder (carbon fiber)



**SC-8106**  
Complete swing arm set for rally setup.



**SC-8107**  
Body mount set.



**SC-8111**  
Steel 3 mm axle spacers.  
**SC-8112**  
Plastic 3 mm axle spacers.



**SC-8113**  
Body Spacers 2 mm.



**SC-8120 NEW**  
Body special allen fixing screw



**SC-8114**  
Motor mount



**SC-8116**  
Motor mount stopper

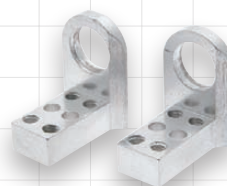

**SC-8108a** Axle holder 7 mm height  
**SC-8108b** Axle holder 8 mm height  
**SC-8108c** Axle holder 9 mm height  
**SC-8108d** Axle holder 10 mm height  
**SC-8108e** Axle holder 11 mm height

(suitable for front and rear axle)



**SC-8115**  
Motor mount can fixing



**SC-8109a** Axle holder 7 mm height  
**SC-8109b** Axle holder 8 mm height  
**SC-8109c** Axle holder 9 mm height  
**SC-8109d** Axle holder 10 mm height  
**SC-8109e** Axle holder 11 mm height



**SC-8126a**  
Aluminium body suspension supports (blue - 2 mm height)



**SC-8126b**  
Aluminium body suspension supports (purple - 3 mm height)



**SC-8126c**  
Aluminium body suspension supports (copper - 4 mm height)



**SC-8126d**  
Aluminium body suspension supports (black - 5 mm height)



**SC-8126e**  
Aluminium body suspension supports (red - 6 mm height)

**NEW**



Aluminium hubs for 3mm axle

Supplied in bags of 2 units with M3 screw

for foam tyres



Lightweight Design			
Width	Ø D1	Ø D2	Reference
8,0 mm	21,0 mm	21,0 mm	SC-4003
13,0 mm	21,0 mm	21,0 mm	SC-4004



Corse Design			
Width	Ø D1	Ø D2	Reference
10,0 mm	21,0 mm	21,0 mm	SC-4000
16,0 mm	21,0 mm	21,0 mm	SC-4001

for rubber tyres

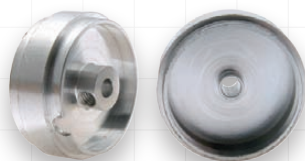

Solid Design			
Width	Ø D1	Ø D2	Reference
10,0 mm	21,5 mm	23,5 mm	SC-4042
13,0 mm	21,5 mm	23,5 mm	SC-4043



Jarama			
Width	Ø D1	Ø D2	Reference
10,0 mm	19,0 mm	21,0 mm	SC-4057e
13,0 mm	19,0 mm	21,0 mm	SC-4056e



Lightweight Design			
Width	Ø D1	Ø D2	Reference
9,0 mm	20,0 mm	22,2 mm	SC-4037b
10,0 mm	19,0 mm	21,0 mm	SC-4057f
10,0 mm	20,0 mm	22,0 mm	SC-4055f
10,2 mm	17,3 mm	19,5 mm	SC-4019
10,2 mm	18,0 mm	20,5 mm	SC-4029
11,5 mm	20,0 mm	22,2 mm	SC-4036b
13,0 mm	19,0 mm	21,0 mm	SC-4056f
13,0 mm	20,0 mm	22,0 mm	SC-4050f

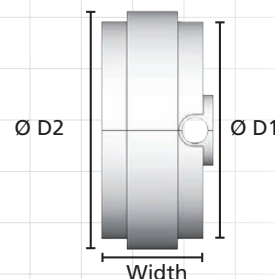

Rubber tyres for 1/24



Width	Ø D1	Minimum Hub Ø D1	Slick				Stripped	
			Standard	RT	Medium	Soft	RT	Soft
10,0 mm	26,0 mm	20,0 mm	SC-4716					
12,0 mm	24,0 mm	16,0 mm		SC-4732		SC-4731	SC-4730	SC-4729
13,0 mm	25,0 mm	20,0 mm						SC-4725
13,0 mm	25,0 mm	19,0 mm		SC-4736	SC-4737			
13,0 mm	27,0 mm	20,0 mm	SC-4717					

Replacement tyres



Width	Diameters in mm		Procomp	Procomp 2	Procomp 3	Hardcomp
	D	D2				
9,0	26,5	21,0		SC-4854	SC-4834	
12,0	28,0	16,0				SC-4841
12,0	28,0	20,0				SC-4840
14,0	26,5	21,0		SC-4853	SC-4833	
20,0	30,0	16,0	SC-4804	SC-4852	SC-4832	
20,0	30,0	20,0	SC-4802	SC-4850	SC-4830	

**Procomp:** Soft high grip foam, specially for cold or low grip tracks. Short life.

**Procomp 2:** Medium high grip foam, with special grip for plastic track.

**Procomp 3:** Hard high grip foam, special for wooden tracks or high grip. Perfect for endurance races.

**Hardcomp:** Hard zero grip foam, for front wheels only.

Supplied in pairs with M3 screw set for 3mm axle

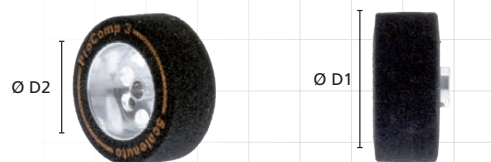

Width	D1 Ø	D2 Ø / Hub Ø	Procomp	Procomp 2	Procomp 3	Hardcomp
8,0 mm	20,5 mm	15,0 mm				SC-2721p
8,0 mm	22,5 mm	17,0 mm				SC-2718p
8,0 mm	23,5 mm	19,0 mm		SC-2632p		SC-2720p
8,0 mm	24,5 mm	21,0 mm				SC-2719p
8,0 mm	25,2 mm	21,0 mm				SC-2710p
8,0 mm	25,5 mm	17,0 mm	SC-2703p	SC-2705p	SC-2707p	SC-2701p
8,0 mm	25,5 mm	19,0 mm				SC-2721p
8,0 mm	25,5 mm	21,0 mm	SC-2704p	SC-2706p	SC-2708p	SC-2702p
8,0 mm	26,5 mm	21,0 mm				SC-2715p
8,0 mm	27,5 mm	21,0 mm				SC-2709p
11,0 mm	20,5 mm	11,0 mm	SC-2010	SC-2011		
11,0 mm	20,5 mm	15,0 mm	SC-2005	SC-2013	SC-2014	SC-2713p
11,0 mm	22,5 mm	15,0 mm	SC-2015	SC-2016		SC-2714p
11,0 mm	25,5 mm	17,0 mm	SC-2109p	SC-2609p	SC-2409p	
11,0 mm	25,5 mm	21,0 mm	SC-2119p	SC-2619p	SC-2419p	
13,0 mm	23,5 mm	15,0 mm			SC-2404p	
13,0 mm	23,5 mm	17,0 mm				SC-2712p
13,0 mm	24,5 mm	17,0 mm			SC-2405p	
13,0 mm	24,5 mm	19,0 mm		SC-2634p		
13,0 mm	25,0 mm	17,0 mm			SC-2406p	
13,0 mm	25,5 mm	17,0 mm	SC-2110p	SC-2610p	SC-2410p	SC-2711p
13,0 mm	25,5 mm	19,0 mm		SC-2636p	SC-2436p	
13,0 mm	25,5 mm	21,0 mm	SC-2120p	SC-2620p	SC-2420p	
13,0 mm	26,5 mm	21,0 mm			SC-2425p	
13,0 mm	26,7 mm	17,0 mm			SC-2407p	
13,0 mm	27,5 mm	17,0 mm			SC-2411p	
13,0 mm	27,5 mm	21,0 mm	SC2121p	SC-2621p	SC-2421p	
16,0 mm	22,0 mm	12,0 mm	SC-2103			
16,0 mm	25,5 mm	17,0 mm	SC-2114p	SC-2614p	SC-2414p	
16,0 mm	27,5 mm	21,0 mm	SC-2124p	SC-2624p	SC-2424p	
18,0 mm	25,5 mm	17,0 mm	SC-2112p	SC-2612p	SC-2412p	
18,0 mm	27,5 mm	17,0 mm			SC-2413p	
18,0 mm	27,5 mm	21,0 mm		SC-2623p	SC-2423p	

## BRM

Width	D1 Ø	D2 Ø / Hub Ø	Procomp	Procomp 2	Procomp 3	Hardcomp
15,5 mm	28,5 mm	23,0 mm	Solid		SC-2426brm	

## Black edition series

Width	D1 Ø	D2 Ø / Hub Ø	Procomp	Procomp 2	Procomp 3	Hardcomp
13,0 mm	25,5 mm	21,0	Lightweight	SC-2620pb	NEW	

## 3/32" Axle

Width	D1 Ø	D2 Ø / Hub Ø	Procomp	Procomp 2	Procomp 3	Hardcomp
20,0 mm	20,5 mm	11,0 mm	SC-2231			

## 1/8" Axle



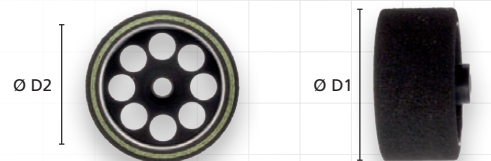

Width	D1 Ø	D2 Ø / Hub Ø	Procomp	Procomp 2	Procomp 3	Hardcomp
20,0 mm	20,5 mm	11,0 mm	SC-2321			



Gears for 3mm axle



Procomp RS In-line

	<p><b>SC-1102</b> Teeth: 32 Screw: M3 ø 17,25 mm</p>		<p><b>SC-1105</b> Teeth: 35 Screw: M3 ø 18,9 mm</p>		<p><b>SC-1107</b> Teeth: 37 Screw: M3 ø 20,0 mm</p>
	<p><b>SC-1104</b> Teeth: 34 Screw: M3 ø 18,35 mm</p>		<p><b>SC-1106</b> Teeth: 36 Screw: M3 ø 19,5 mm <b>• NEW •</b></p>		<p><b>SC-1108</b> Teeth: 38 Screw: M3 ø 20,5 mm</p>



Procomp RS-z AngleWinder

	<p><b>SC-1051b</b> Teeth: 39 Screw: M3 ø 20,5 mm <b>• NEW •</b></p>		<p><b>SC-1054b</b> Teeth: 42 Screw: M3 ø 22,0 mm</p>		<p><b>SC-1057b</b> Teeth: 45 Screw: M3 ø 23,5 mm</p>
	<p><b>SC-1052b</b> Teeth: 40 Screw: M3 ø 21,0 mm <b>• NEW •</b></p>		<p><b>SC-1055b</b> Teeth: 43 Screw: M3 ø 22,5 mm</p>		
	<p><b>SC-1053b</b> Teeth: 41 Screw: M3 ø 21,5 mm</p>		<p><b>SC-1056b</b> Teeth: 44 Screw: M3 ø 23,0 mm</p>		







Axle stoppers

	<p><b>SC-1126</b> Axle stopper 3mm light and anodized M3 screw</p>
---	--

## Guides

	<p><b>SC-1601</b> Pro Guide 3/16" Club 8,5 mm blade</p>		<p><b>SC-1624</b> • NEW • Narrow Pro Guide 3/16" Club racing 9,1mm blade</p>
	<p><b>SC-1602</b> Pro Guide 3/16" Home 7 mm blade</p>		<p><b>SC-1626</b> • NEW • Racing Pro guide 3/16" Club 9,1 mm blade</p>
	<p><b>SC-1622</b> Heavy duty 3/16" Club Racing 9,1mm blade</p>		

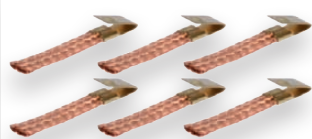
## Guide accessories

	<p><b>SC-1615</b> Guide clips for SC-1601, SC-1602, 1622, 1624 &amp; 1626</p>		<p><b>SC-1623</b> Steel guide spacers for 3/16 guides</p>
	<p><b>SC-1614</b> Universal Soft braid <b>SC-1614b</b> Universal Soft braid 50 units <b>SC-1614c</b> Universal Soft braid.100 units</p>		<p><b>SC-5116</b> M5 inox nuts x 2.5mm for 3/16 guides</p>

## Wheel inserts

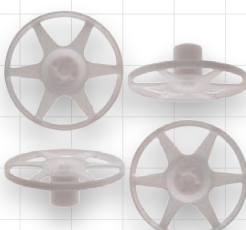
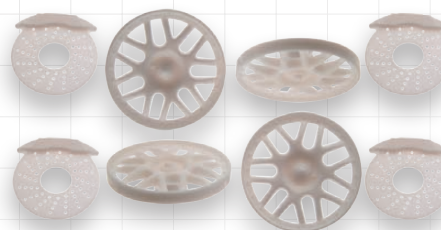
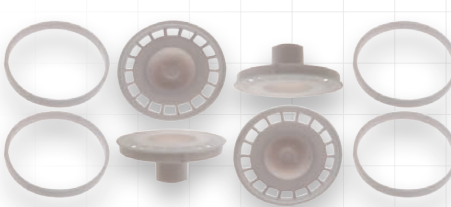
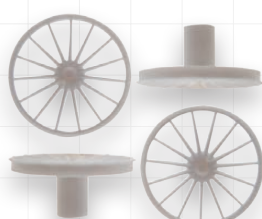
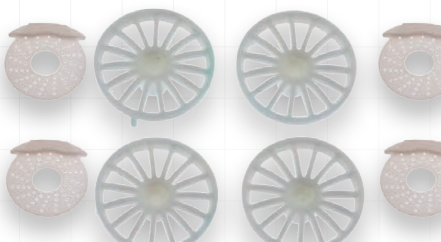
		
<p><b>SC-7609</b> Speedline 15 spokes Wheel insert 16/17 mm.</p>	<p><b>SC-7606</b> Speedline 5 spokes Wheel insert. 20 mm.</p>	<p><b>SC-7610</b> BBS GT Wheel insert 20 mm. with brake disc.</p>
		
<p><b>SC-7607</b> OZ Wheel insert.16/17 mm</p>	<p><b>SC-7608</b> Speedline 15 spokes. Wheel insert. 20 mm.</p>	<p><b>SC-7615</b> • NEW • BBS GT 15 Spokes Wheel insert 20 mm. with brake disc.</p>

# HSV-010 Super GT • NEW •

SC-6031  
JGTC 2010 #100

Raybrig



SC-6015  
JGTC 2010 #8  
Autobacs



SC-6030  
JGTC 2010 #32  
Nakajima Epson



SC-6012  
Presentation  
Raybrig



	S-CAN	LONG-CAN	SHORT-CAN	SLIM-CAN	FLAT-CAN
In-line	YES	YES	YES	NO	YES
Side Winder	YES	NO	YES	NO	NO
Angle Winder	YES	YES	YES	NO	YES

	Reference	Motor	Motor Size	Ratio	Magnet	Chassis	Lights	Front (mm)		Rear (mm)	
								ø Tire	Hub	ø Tire	Hub
Presentation	SC-6012	SC-08b	Sidewinder Short Can	12/32	YES	RT3 LWB	NO	18 x 9	17,5 x 9	19 x 10,5	17,5 x 10
JGTC 2010 #8	SC-6015							Standard	Plastic	Standard	Aluminium
JGTC 2010 #32	SC-6030										
JGTC 2010 #100	SC-6031										



• NEW •

# SPYKER C8 GT2R

SC-6042a

24h Le Mans 2006 #85



Spyker Squadron BV



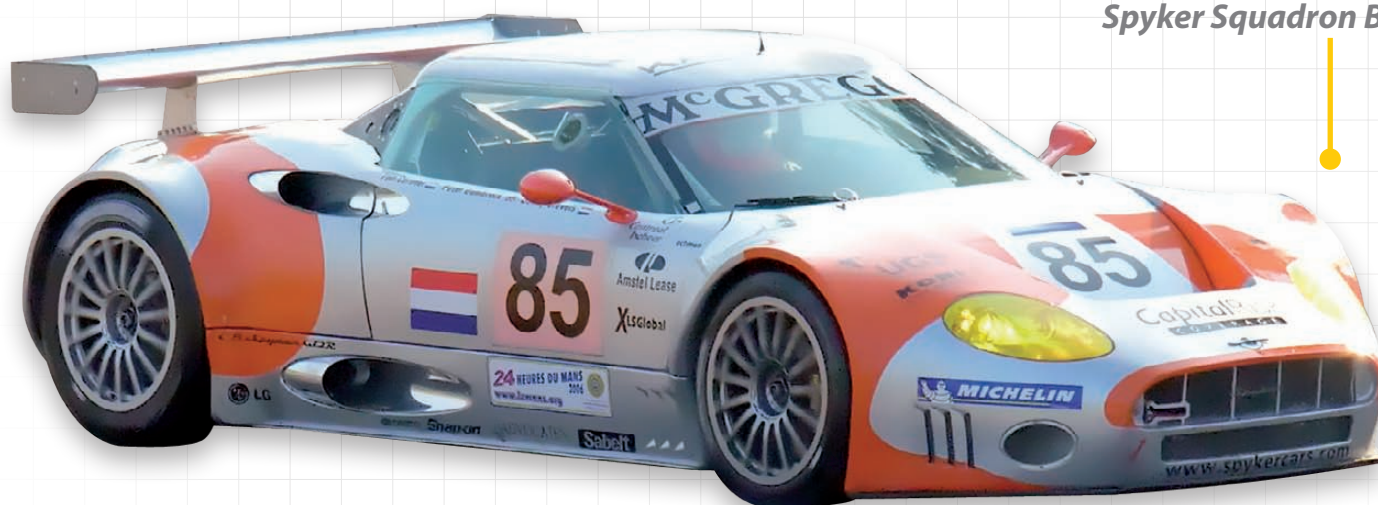

SC-6042b  
24h Le Mans 2006 #86

Spyker Squadron BV



	S-CAN	LONG-CAN	SHORT-CAN	SLIM-CAN	FLAT-CAN
In-line 	YES	YES	YES	NO	YES
Side Winder 	YES	NO	YES	NO	NO
Angle Winder 	YES	YES	YES	NO	YES

	Reference	Motor	Motor Size	Ratio	Magnet	Chassis	Lights	Front (mm)		Rear (mm)	
								ø Tire	Hub	ø Tire	Hub
24h Le Mans 2006 #86	SC-6042a	SC-08b	SideWinder 	12/32	YES	RT3 LWB	NO	18 x 9 Standard	17,5 x 9 Plastic	19 x 10,5 Standard	17,5 x 10 Aluminium
24h Le Mans 2006 #85	SC-6042b	SC-08b	Short Can 								

# BMW Z4 GT3

• NEW •

SC-6017

Presentation #1



SC-6018

24h Dubai 2011 #17

Team Engstler

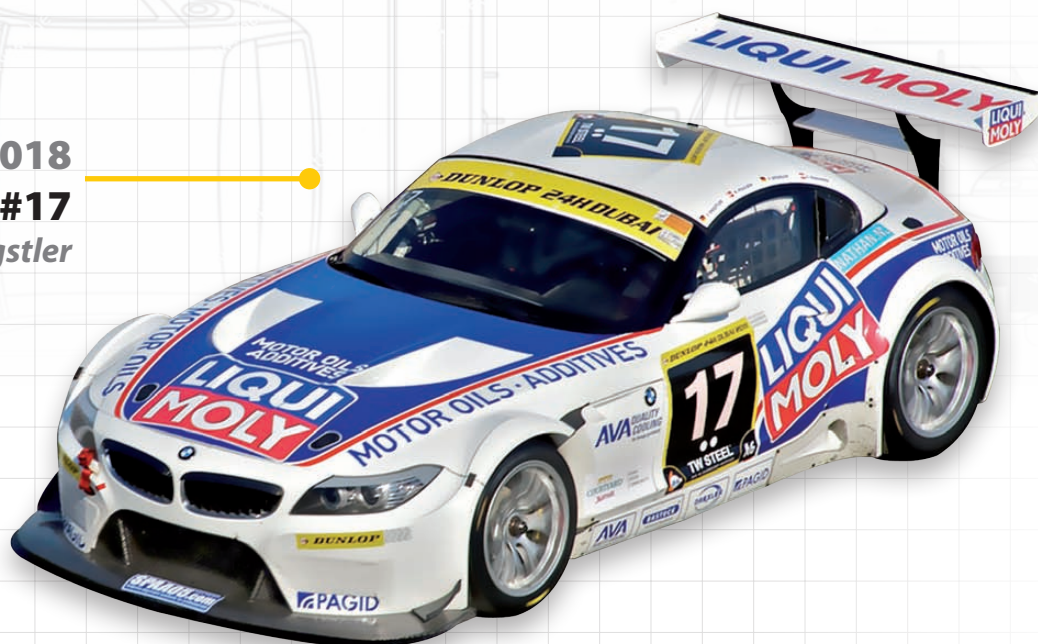

SC-6020

24h Barcelona 2011 #2

Schubert Motorsport

	S-CAN	LONG-CAN	SHORT-CAN	SLIM-CAN	FLAT-CAN
In-line	YES	YES	YES	NO	YES
Side Winder	YES	NO	YES	NO	NO
Angle Winder	YES	YES	YES	NO	YES

	Reference	Motor	Motor Size	Ratio	Magnet	Chassis	Lights	Front (mm)		Rear (mm)	
								ø Tire	Hub	ø Tire	Hub
Presentation #1	SC-6017	SC-08b	Sidewinder	12/32	YES	RT3 MWB	NO	18 x 9	17,5 x 9	19 x 10,5	17,5 x 10
24h Dubai 2011 #17	SC-6018							Standard	Plastic	Standard	Aluminium
24h Barcelona 2011 #2	SC-6020							Short Can			

# Mercedes Benz SLS AMG GT3

• NEW • SC-6021

VLN Nürburgring 2011 #15

Mamerow Racing

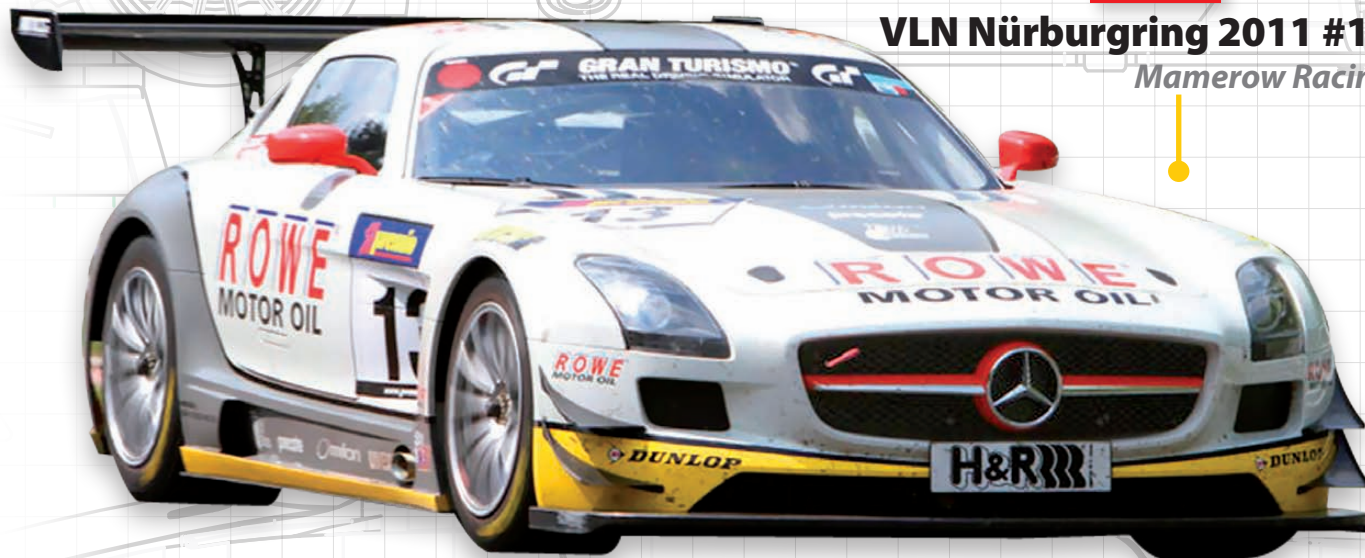

SC-6023 • NEW •

24h Nürburgring 2011 #3

Black Falcon



SC-6022

IberGT 2011 Jarama #25

Vodafone BP Ultimate Team

	S-CAN	LONG-CAN	SHORT-CAN	SLIM-CAN	FLAT-CAN
In-line	YES	YES	YES	NO	YES
Side Winder	YES	NO	YES	NO	NO
Angle Winder	YES	YES	YES	NO	YES

	Reference	Motor	Motor Size	Ratio	Magnet	Chassis	Lights	Front (mm)		Rear (mm)	
								ø Tire	Hub	ø Tire	Hub
VLN Nürburgring 2011 #15	SC-6021		In-Line					18 x 9	17,5 x 9	19 x 10,5	17,5 x 10
IberGT Jarama 2011 #25	SC-6022	SC-25		27/9	YES	RT2	NO	Standard	Plastic	Standard	Aluminium
VLN Nürburgring 2011 #3	SC-6023		Long Can								

# Pagani Zonda • NEW •

**SC-6044**  
**Brno 2010 #39**  
Rock Media Motors



**SC-6045**  
**24h Le Mans Test 2004 #60**  
Force One Racing

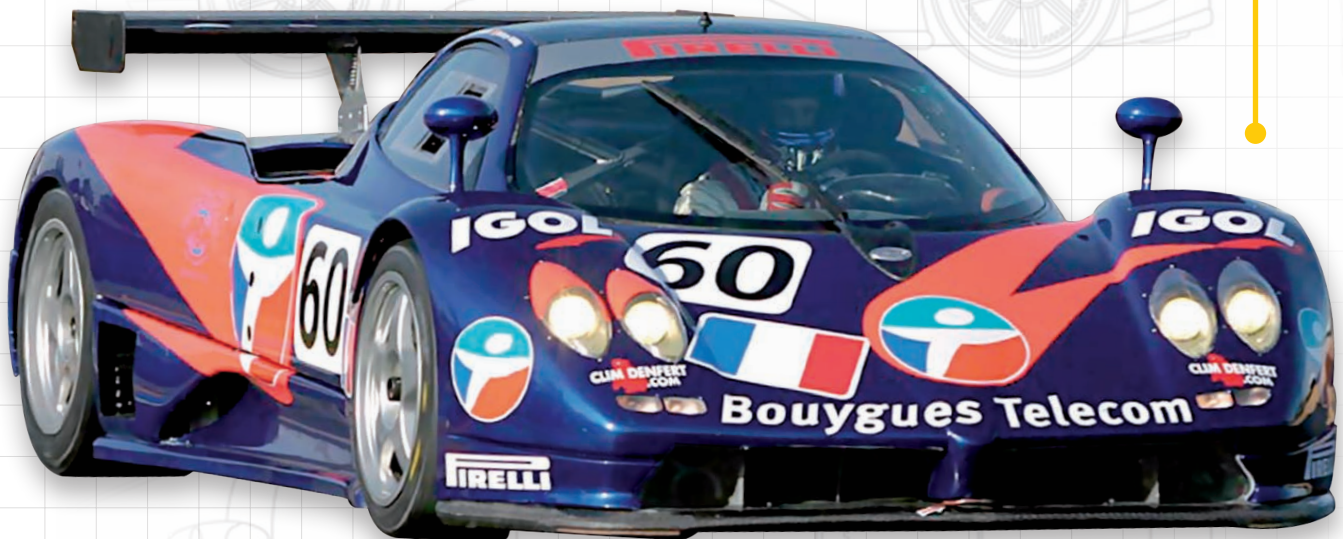

	S-CAN	LONG-CAN	SHORT-CAN	SLIM-CAN	FLAT-CAN
In-line	YES	YES	YES	NO	YES
Side Winder	YES	NO	YES	NO	NO
Angle Winder	YES	YES	YES	NO	YES

	Reference	Motor	Motor Size	Ratio	Magnet	Chassis	Lights	Front (mm)		Rear (mm)	
								ø Tire	Hub	ø Tire	Hub
Brno 2010 #39	SC-6044	SC-25	In-Line	27/9	YES	RT2	NO	18 x 9 Standard	17,5 x 9 Plastic	19 x 10,5 Standard	17,5 x 10 Aluminium
24h Le Mans Test 2004 #60	SC-6045		Long Can								

# Radical SR-9

## SC-6011

### 24h Le Mans 2010 #28

Race Performance AG



## SC-6010

### 24h Le Mans 2009 #26

Bruichladdich Bruneau



• New chassis RT2 & EVO-6 compatible •

	S-CAN	LONG-CAN	SHORT-CAN	SLIM-CAN	FLAT-CAN
In-line	YES	YES	YES	NO	YES
Side Winder	NO	NO	NO	NO	NO
Angle Winder	NO	NO	NO	NO	YES

	Reference	Motor	Motor Size	Ratio	Magnet	Chassis	Lights	Front (mm)		Rear (mm)	
								ø Tire	Hub	ø Tire	Hub
24h Le Mans 2006 #22	SC-6006	SC-11	In-Line	27/9	YES	RT	NO	18 x 9 Standard	17,5 x 9 Plastic	19 x 10,5 Standard	17,5 x 10 Aluminium
24h Le Mans 2007 #21	SC-6009					RT-2					
24h Le Mans 2009 #26	SC-6010	SC-25	Long Can								
24h Le Mans 2010 #28	SC-6011										

# M1 Gr. 5 • NEW •

SC-6039

500 Km Fuji 1982 #8

Team Seelex

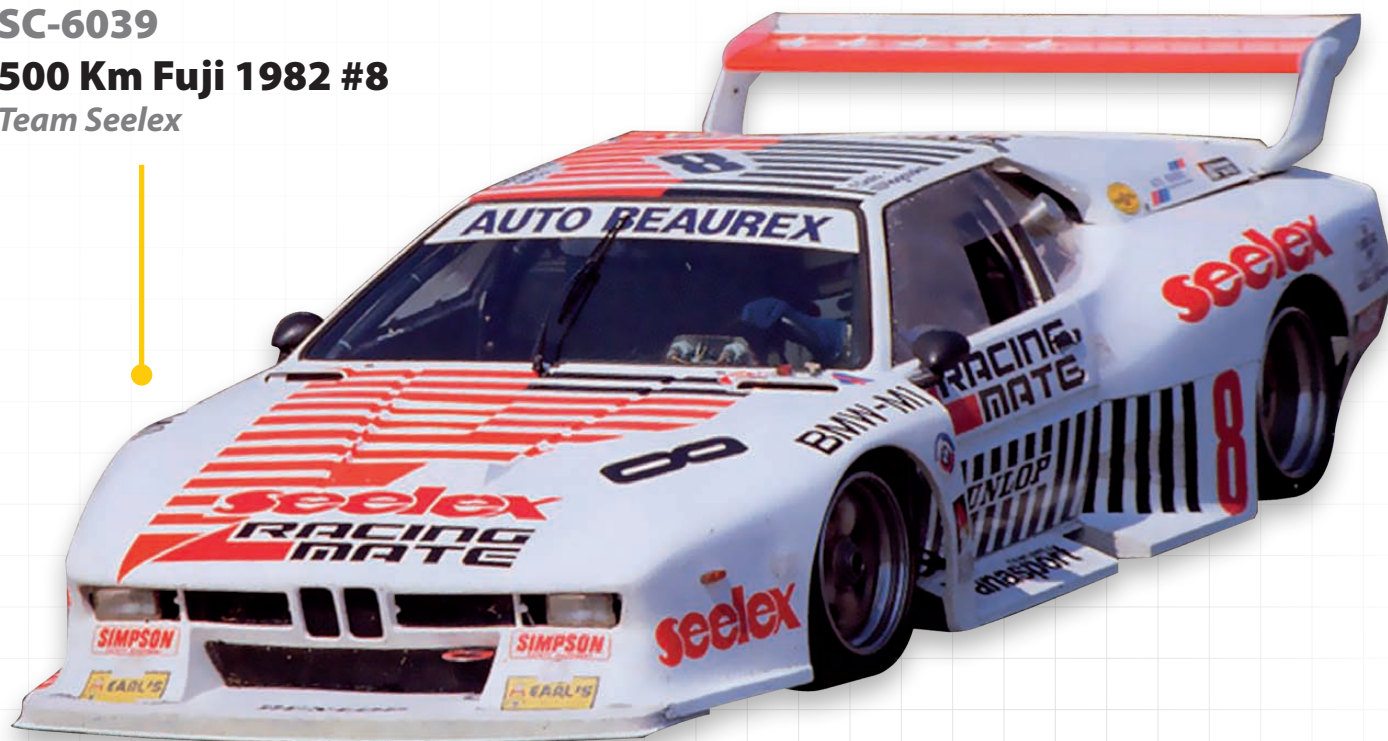

SC-6024

24h Le Mans 1981 #53

Emka Productions Ltd



SC-6027

24h Le Mans 1981 #52

Wurth Team Sauber



	S-CAN	LONG-CAN	SHORT-CAN	SLIM-CAN	FLAT-CAN
In-line	YES	YES	YES	NO	YES
Side Winder	YES	NO	YES	NO	NO
Angle Winder	YES	YES	YES	NO	YES

	Reference	Motor	Motor Size	Ratio	Magnet	Chassis	Lights	Front (mm)		Rear (mm)	
								ø Tire	Hub	ø Tire	Hub
24h Le Mans 1981 #53	SC-6024		Sidewinder					18 x 9	16,9 x 9	19 x 10,5	16,9 x 9
24h Le Mans 1981 #52	SC-6027	SC-08b		12/32	YES	RT3 LWB	NO	Standard	Plastic	Standard	Aluminium
500 Km Fuji 1982 #8	SC-6039		Short Can								

# • NEW • DeTomaso Pantera Gr. 3

SC-6034

• Prepainted Kit with decals •

**24h Le Mans 1976 #82**  
André Wicky - Martial Deblande

**24h Le Mans 1974 #52**  
Wicky Racing Team





SC-6035

**24h Le Mans 1975 #7**  
Beurlys Inter Auto

SC-6040

**DRM #318 Jagermeister**



	S-CAN	LONG-CAN	SHORT-CAN	SLIM-CAN	FLAT-CAN
In-line 	YES	YES	YES	NO	YES
Side Winder 	YES	NO	YES	NO	NO
Angle Winder 	YES	YES	YES	NO	YES

	Reference	Motor	Motor Size	Ratio	Magnet	Chassis	Lights	Front (mm)		Rear (mm)	
								ø Tire	Hub	ø Tire	Hub
24h Le Mans 1974 #52 / 1976 #82	SC-6034		Sidewinder								
24h Le Mans 1975 #7	SC-6035	SC-08b		12/32	YES	RT3	NO	18 x 9 Standard	16,9 x 9 Plastic	19 x 10,5 Standard	16,9 x 9 Aluminium
DRM #318	SC-6040		Short Can								

# All new **RT3** Chassis Design • NEW •

Valid for In-line, Sidewinder and Anglewinder motor mounts

### 2 front fixing arms style for motor mounts

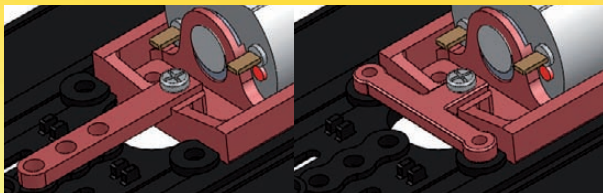

Geometry and properties can be easily modified exchanging this piece. Up to 4 motor mount front fixing points. Extended range of compatibility for motor mounts from third party brands.

### Easily rear magnet assembly

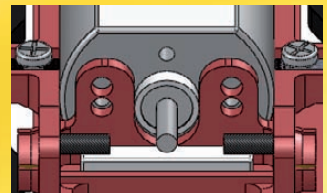

With only 2 screws allows an easy to fix, adjustable rear magnet installation to assure the maximum speed.

### Wire fixings

Wiring supports for clear installation on chassis surface

### Adjustable suspension post

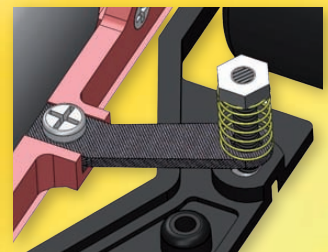

Sided screws to adjust the motor mount vertical play. They also allow the mounting of suspension kit.

### Adjustable suspension post

4 motor mount rear fixing post with adjustable vertical play or suspension assembly.

### One chassis for different bodies

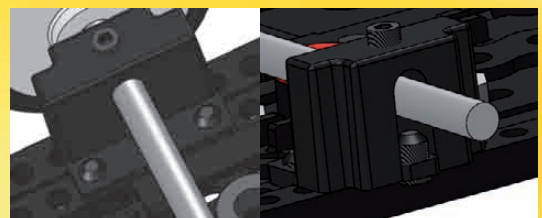

Adjustable car wheelbase, modifying the position of front axle housing. Adjustable front axle height to minimize the friction. Now using 1 chassis for different bodies is possible!!

### Independent guide holder

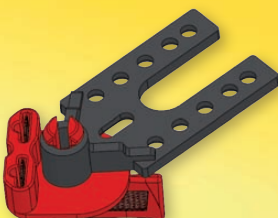

Adjustable guide position to rear and front axle.

2 lenght available

Surface distance also adjustable using fine spacers

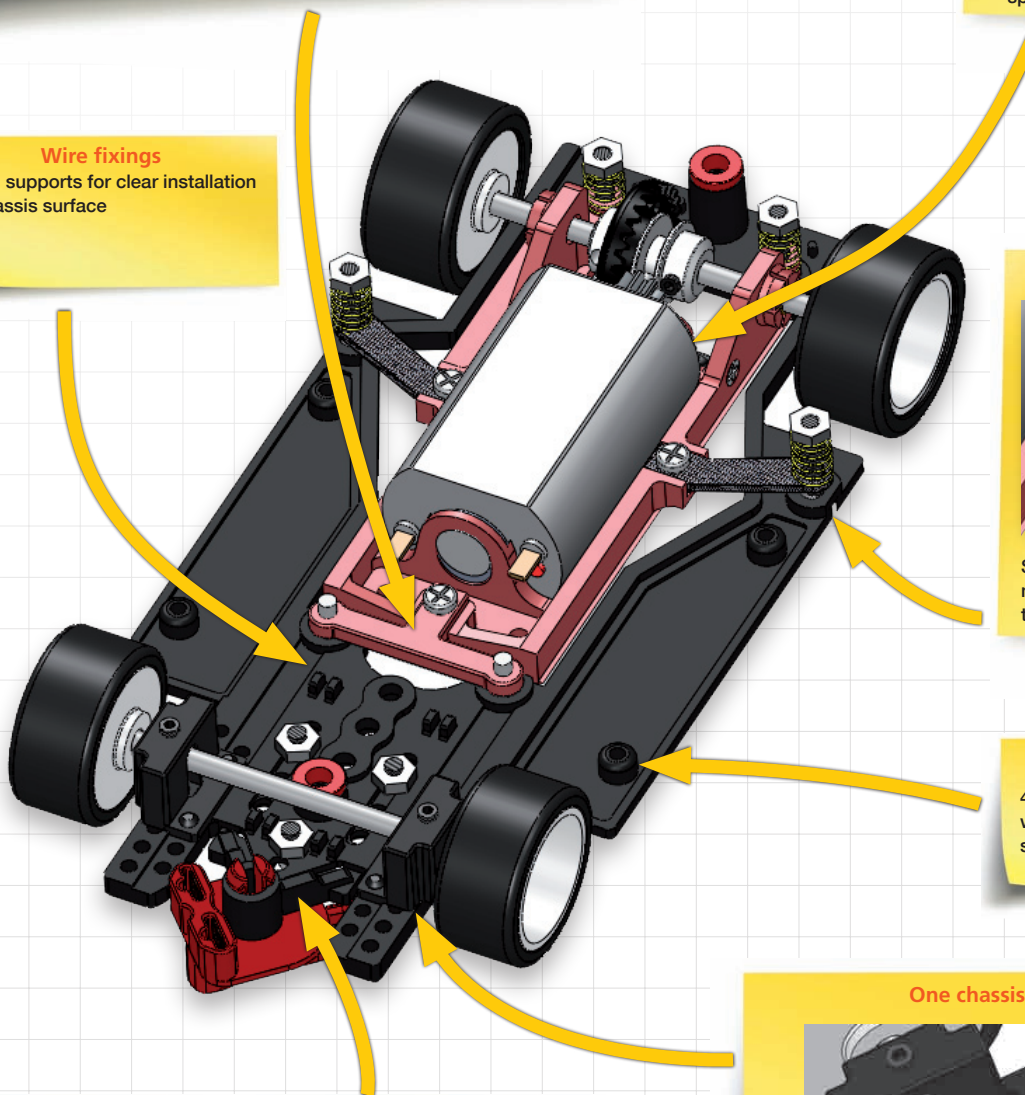

The new chassis design will be available in 2 versions, as following:

Reference	Description	Width (mm)	Wheelbase (mm)
SC-6615	Medium Wheel Base Chassis (MWB)	50'6	77-84
SC-6616	Long Wheel Base Chassis (LWB)	57,0	81-86



**RT3 Motor Mounts**

• NEW •

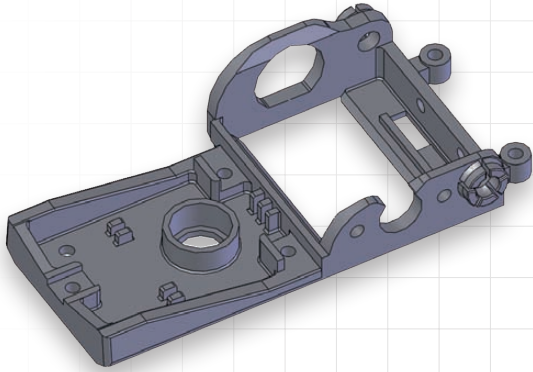

**SC-6522**  
RT3 Sidewinder motor mount offset 0.5 mm

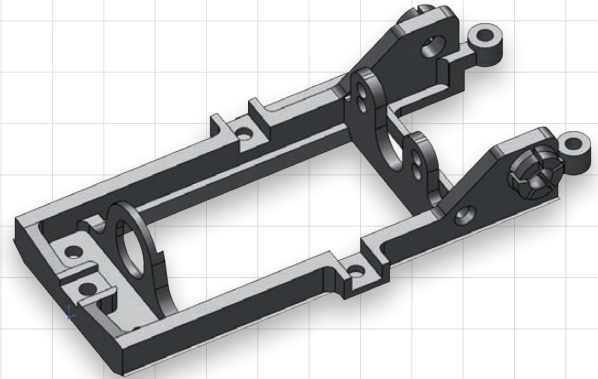

**SC-6523**  
RT3 Inline motor mount offset 0.0 mm

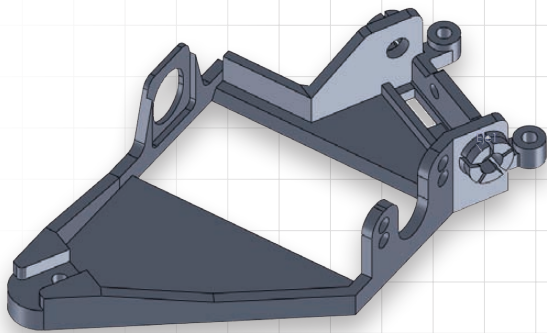

**SC-6524**  
RT3 Anglewinder motor mount offset 0.5 mm

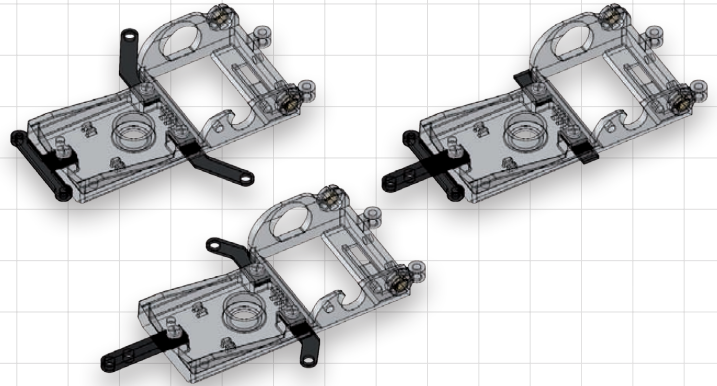

Reference	Motor Mount multi-chassis adapter arms
SC-6525a	For Sidewinder motor mount
SC-6525b	For inline motor mount
SC-6525c	For Anglewinder motor mount

**Chassis RT3**

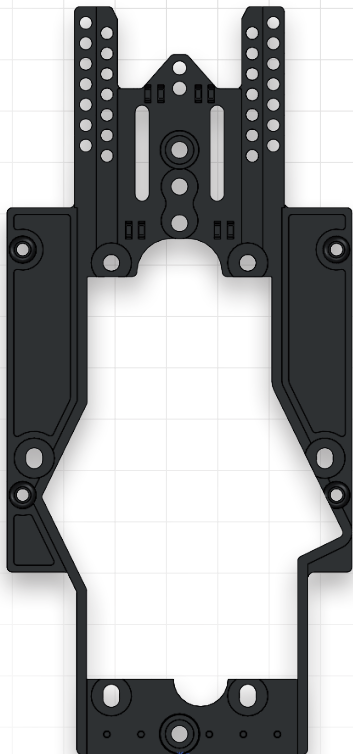

**SC-6615**  
MWB Chassis Medium Wheel Base (78-86 mm)

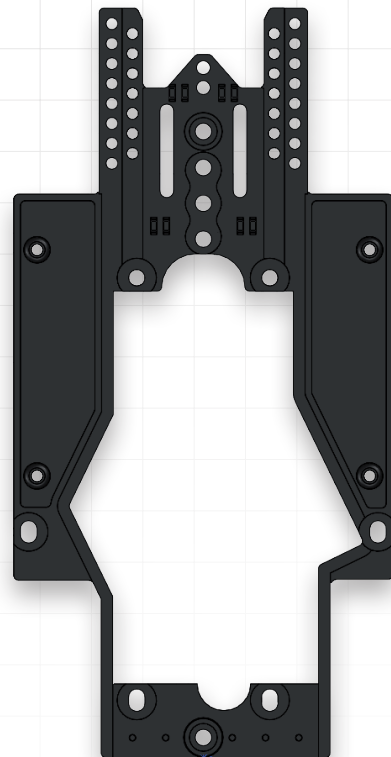

**SC-6616**  
LWB Chassis Long Wheel Base (82-89 mm)

**Chassis RT2**

**Chassis Toyota GT One**  
**SC-6605** Hard

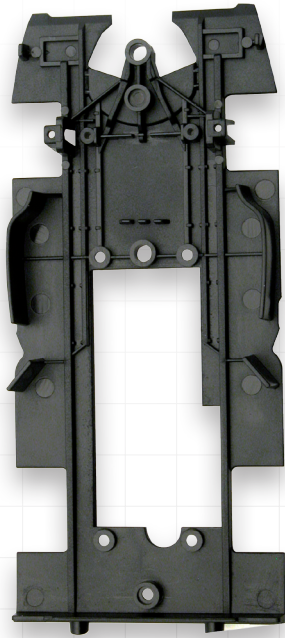

**Chassis Radical SR-9**  
**SC-6612** Hard  
**SC-6612b** Medium  
**SC-6612c** Soft

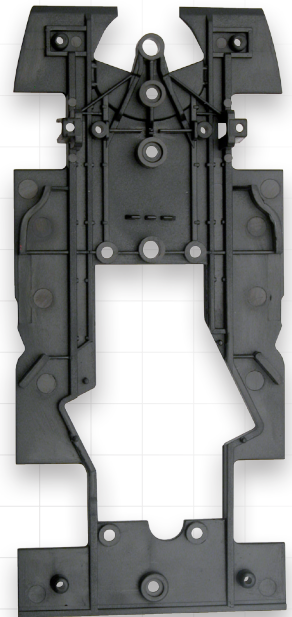

**Chassis Radical SR-9 Evo2**  
**SC-6612a2** Hard  
**SC-6612b2** Medium  
**SC-6612c2** Soft

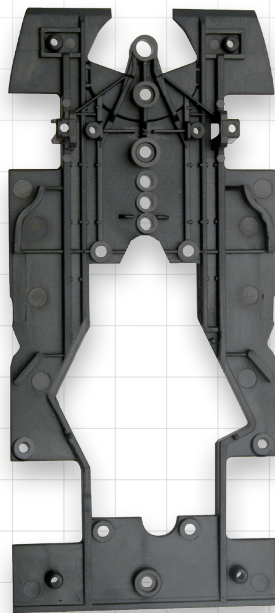

**Chassis Mercedes**  
**SC-6613a** Hard  
**SC-6613b** Medium  
**SC-6613c** Soft

**• NEW •**

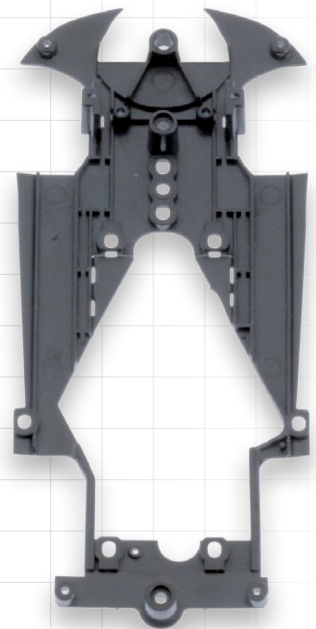

**RT2 Motor Mounts**



**SC-6520**  
RT2 In-Line motor mount adapter for Long-can and flat motors

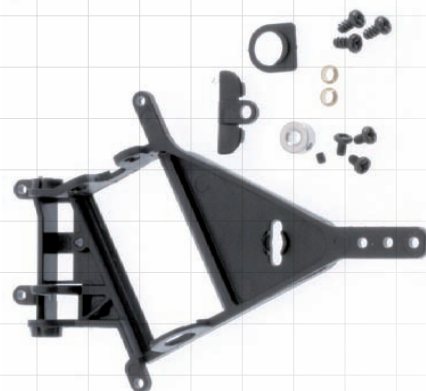

**SC-6521**  
RT2 AngleWinder motor mount adapter for Long-can and flat motors

## Aluminium / Carbon Motor Mounts

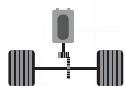

### In-Line

#### SC-3000b

PRO RT In-Line Aluminium.

Motor mount for:

Scaleauto • MSC • Slot.It • Racer sideways

- ✓ Perfect CNC Aluminium machined.
- ✓ Ultra light design for minimum weight and maximum speed.
- ✓ Interchangeable motor mount with or without offset set inline gears.
- ✓ Optional High Speed Ball Bearing (SC-1321).

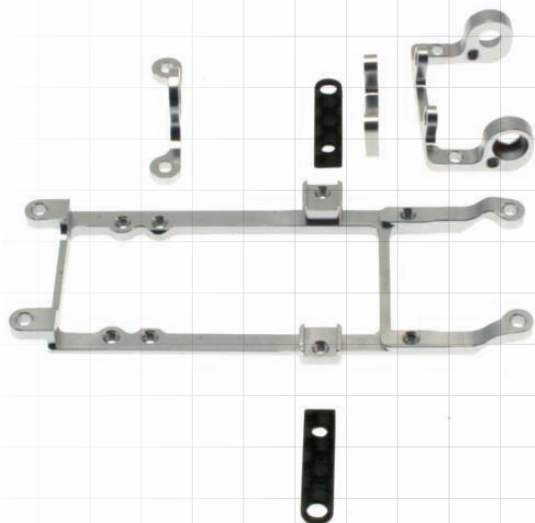

#### SC-3050

Offset Motor mount -0,5mm.

(Only for discontinued reference SC-3000)



#### SC-3051

Magnet mount for 2 x SC-1502 neodimium magnets.

Adjustable height with double screw fixing.

(Only for discontinued reference SC-3000)

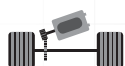

### AngleWinder

#### SC-3001c

PRO-RT Anglewinder Aluminium motor mount.

- ✓ Perfect CNC aluminium motor mounts.
- ✓ Ultra light design for minimum weight and maximum speed.
- ✓ Anglewinder motor mount compatible with plastic chassis from:  
Scaleauto • Racer Sideways • MSC • Slot.It
- ✓ Allow LONG can or FLAT can motors.
- ✓ Optional High Speed Ball Bearing (SC-1321).
- ✓ Compatible with chassis type RT-2 and EVO-6.

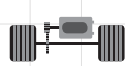

### SideWinder

#### SC-3004b

PRO-RT Sidewinder

Aluminium motor mount for NSR classic.

- ✓ Perfect CNC aluminium motor mounts.
- ✓ Ultra light design for minimum weight and maximum speed.
- ✓ Sidewinder motor mount compatible with plastic chassis from NSR.
- ✓ Allow S-CAN.
- ✓ Optional High Speed Ball Bearing (SC-1321).

• UPDATED DESIGN •

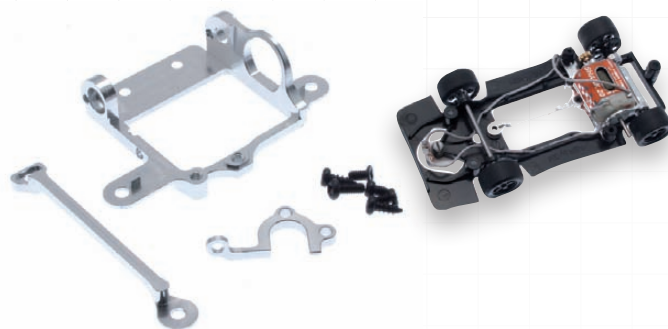

**Suzuka Aluminium Anodized** • NEW •

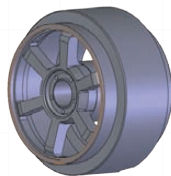

● Black Anodized

Diameters in mm		Width	Reference
D	D2		
14,8	12,7	8,5 mm	SC-4030g
15,5	13,3		SC-4053g
15,8	13,6		SC-4031g
16,2	14,0		SC-4049g
17,2	15,0		SC-4034g
17,5	15,3		SC-4052g

**Sebring Aluminium Anodized** • NEW •



● Dark Grey Anodized

Diameters in mm		Width	Reference
D	D2		
14,8	12,7	8,5 mm	SC-4030h
15,5	13,3		SC-4053h
15,8	13,6		SC-4031h
16,2	14,0		SC-4049h
17,2	15,0		SC-4034h
17,5	15,3		SC-4052h

**Lightweight Universal**



Diameters in mm		Width	Reference
D	D2		
14,8	12,7	8,5 mm	SC-4030f
15,8	13,6	8,5 mm	SC-4031f
15,8	13,6	10,0 mm	SC-4032f
17,2	15,0	10,0 mm	SC-4033f
17,2	15,0	8,5 mm	SC-4034f
14,8	12,7	10,0 mm	SC-4035f
16,5	14,3	8,5 mm	SC-4046f
16,9	14,7	8,5 mm	SC-4048f
16,2	14,0	8,5 mm	SC-4049f
16,2	14,0	10,0 mm	SC-4051f
17,5	15,3	8,5 mm	SC-4052f
15,5	13,3	8,5 mm	SC-4053f
16,5	14,3	10,0 mm	SC-4054f
17,5	15,3	10,0 mm	SC-4062f

**Jarama Aluminium Gold Anodized**



Diameters in mm		Width	Reference
D	D2		
15,5	13,3	8,5 mm	SC-4053e
15,8	13,6		SC-4031e
16,2	14,0		SC-4049e
16,5	14,3		SC-4046e
16,9	14,7		SC-4048e
17,2	15,0		SC-4034e
17,5	15,3	SC-4052e	

**Monza Magnesium**



Diameters in mm		Width	Reference
D	D2		
14,8	12,7	8,0 mm	SC-4030b
16,5	14,3	8,0 mm	SC-4046b
14,8	12,7	10,0 mm	SC-4035b
15,8	13,6	10,0 mm	SC-4032b

**Solid Design** • NEW •

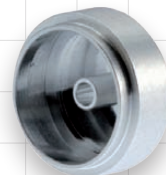

Diameters in mm		Width	Reference
D	D2		
15,0	12,8	8,0 mm	SC-4063a
15,8	13,6	8,5 mm	SC-4031a
16,9	14,1		SC-4048a
17,5	15,5		SC-4052a

**Monza-2 Aluminium**



Diameters in mm		Width	● Silver	○ Black	● Blue	● Dark grey
D	D2					
16,5	14,3	8,0 mm		SC-4046d2		
16,9	14,7	8,0 mm		SC-4048d2	SC-4048d3	SC-4048d4
14,8	12,7	8,5 mm		SC-4030d		
15,5	13,3		SC-4053d			
15,8	13,6		SC-4031d			
16,2	14,0		SC-4049d			
17,2	15,0		SC-4034d			
17,5	15,3		SC-4052d			
14,8	12,7	10,0 mm		SC-4035d		
15,8	13,6		SC-4032d			
16,2	14,0		SC-4051d			
16,5	14,3		SC-4054d			
17,2	14,0		SC-4033d			
17,5	15,3		SC-4062d			

**Imola Aluminium**



Diameters in mm		Width	● Silver	● Black	● Blue	● Dark grey
D	D2					
15,8	13,6	8,0 mm	SC-4031c	SC-4031c2	SC-4031c3	
16,5	14,3		SC4046c	SC4046c2	SC4046c3	
16,9	14,7		SC-4048c	SC-4048c2	SC-4048c3	SC-4048c4

**Procomp:** Soft high grip foam, specially for cold or low grip tracks. Short life.

**Procomp 2:** Medium high grip foam, with special grip for plastic track.

**Procomp 3:** Hard high grip foam, specially for wooden tracks or high grip. Perfect for endurance races.

**Hardcomp:** Hard zero grip foam, for front wheels only.

Supplied in pairs with M3 screw set for 3mm axle

### 3/32" Axle



Width	D1 Ø	D2 Ø / Hub Ø	Procomp	Procomp 2	Procomp 3	Hardcomp
8	20,5	15,0				SC-2717p • NEW •
9	19,0	15,0			SC-2019	• NEW •
9	20,5	15,0			SC-2018	• NEW •
11	20,5	11,0	SC-2004			
11	20,5	15,0	SC-2007	SC-2008	SC-2009	

### 2/5 Axle

Width	D1 Ø	D2 Ø / Hub Ø	Procomp	Procomp 2	Procomp 3	Hardcomp
11	20,5	11,0	SC-2002			

## Rubber tyres for 1/32



Ø D1	Width	Ø D2	Type Hardness				
			Standard	Zero Grip	RT	Medium	Soft
15,8 mm	8,0 mm	13,0 mm			SC-4742	• NEW •	
16,0 mm	8,5 mm	14,0 mm		SC-4724	SC-4738		
17,5 mm	10,0 mm	16,0 mm		SC-4723			
18,5 mm	10,0 mm	15,0 mm	SC-4718				
18,0 mm	9,0 mm	14,5 mm			SC-4734	SC-4739	
19,5 mm	10,0 mm	15,0 mm			SC-4735	SC-4740	
19,5 mm	8,8 mm	15,0 mm	SC-4719				
19,0 mm	9,5 mm	15,0 mm	SC-4741				
19,0 mm	10,0 mm	14,0 mm			SC-4720		SC-4726
19,0 mm	10,5 mm	15,0 mm			SC-4733		
20,0 mm	10,0 mm	16,0 mm			SC-4722		SC-4728
20,0 mm	12,0 mm	14,0 mm			SC-4721		SC-4727

Rubber tyres for profile hubs. Supplied in bags of 4 units.

## Carbon fiber sheet

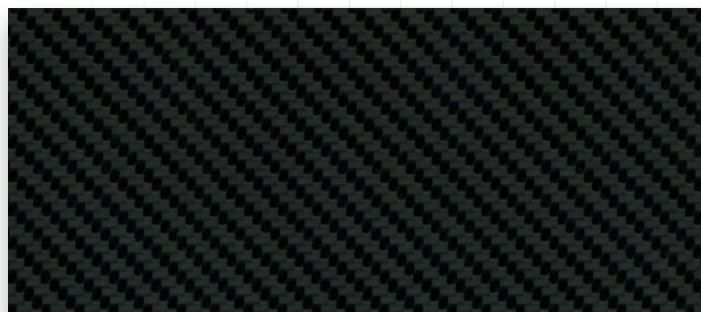

### SC-3500

Carbon fiber sheet 140 x 62 x 1mm

### SC-3501

Carbon fiber sheet 140 x 100 x 1mm

**Body Kits and Body Spare Pieces**

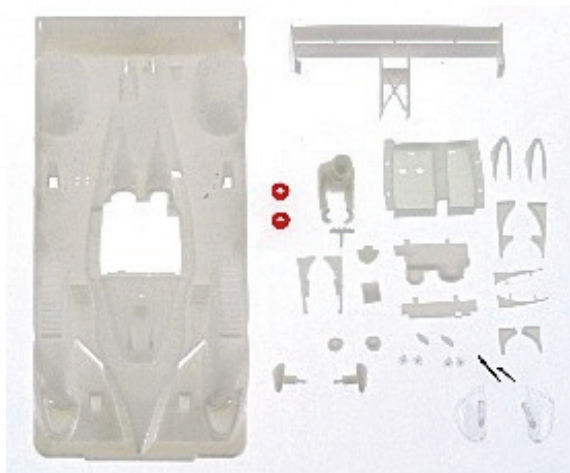

Reference	Body kits
SC-3600	Toyota GT One (white)
SC-3600b	Toyota GR One painted body (red)
• NEW • SC-3601	Radical SR9 (white)
• NEW • SC-3602	Mercedes SLS GT3 (white)

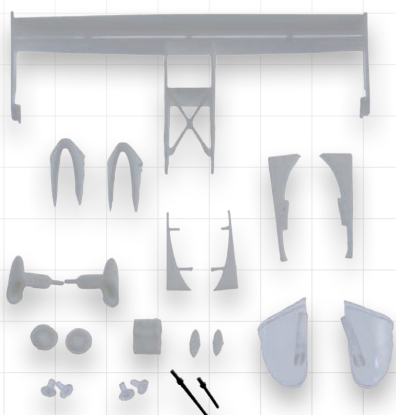

Reference	Body spare parts
SC-3601b	Radical SR9
SC-3602b	Mercedes SLS GT3
SC-3603b	Honda HSV-010 <b>• NEW •</b>
SC-3604b	BMW Z4 GT3 <b>• NEW •</b>
SC-3605b	Spyker C8 <b>• NEW •</b>
SC-3606b	Pagani Zonda <b>• NEW •</b>

**Lexan Internal cockpit**



Reference	Complete light cockpit and clear pieces
SC-6602	Toyota GT-One
SC-6611	Radical SR-9
SC-6614	Mercedes SLS AMG GT3 <b>• NEW •</b>
SC-6617	Honda HSV-010 <b>• NEW •</b>
SC-6618	BMW Z4 GT3 <b>• NEW •</b>
SC-6619	Spyker C8 <b>• NEW •</b>

**Carbon Performance Kit**

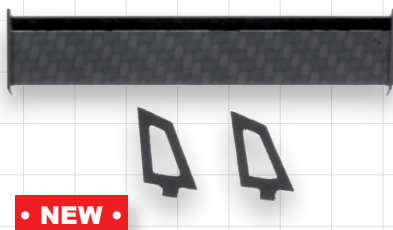

• NEW •

Reference	Rear wing (Rubber + Carbon fiber)
SC-3601c	Radical SR9
SC-3602c	Mercedes SLS AMG GT3
SC-3603c	Honda HSV-010
SC-3604c	BMW Z4 GT3
SC-3605c	Spyker C8 GT2R
SC-3606c	Pagani Zonda

## Gears





### In-line Procomp RS

	<b>SC-1109</b> Teeth: 23 Screw: M3 + STOPPER ø 12,8 mm		<b>SC-1112</b> Teeth: 26 Screw: M2 + STOPPER ø 14,1 mm		<b>SC-1100</b> Teeth: 30 Screw: M2 + STOPPER ø 16,2 mm
	<b>SC-1110</b> Teeth: 24 Screw: M2 + STOPPER ø 13,1 mm		<b>SC-1113</b> Teeth: 27 Screw M2 + STOPPER ø 14,8 mm.	<b>SC-1123</b> STOPPER Aluminium Screw: M2 + STOPPER	
	<b>SC-1111</b> Teeth: 25 Screw: M2 + STOPPER ø 13,5 mm		<b>SC-1114</b> Teeth: 28 Screw: M2 + STOPPER ø 15,4 mm		



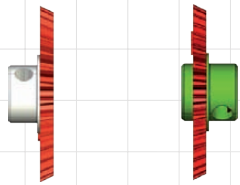

### Anglewinder Procomp RS



	<b>SC-1165</b> • Tooth: 25 <b>SC-1166</b> • Tooth: 26 <b>SC-1167</b> • Tooth: 27 <b>SC-1168</b> • Tooth: 28 <b>SC-1169</b> • Tooth: 29 <b>SC-1170</b> • Tooth: 30		<b>SC-1175</b> • Tooth: 25 <b>NEW</b> <b>SC-1176</b> • Tooth: 26 <b>NEW</b> <b>SC-1177</b> • Tooth: 27 <b>NEW</b> <b>SC-1178</b> • Tooth: 28
For 25° motor mounts. Screw: M2 • ø 15,8 mm	<b>SC-1179</b> • Tooth: 29 <b>SC-1180</b> • Tooth: 30 <b>SC-1181</b> • Tooth: 31 <b>SC-1182</b> • Tooth: 32		
	<b>SC-1171</b> • Tooth: 31 <b>SC-1171b</b> • Tooth: 31 * <b>SC-1172</b> • Tooth: 32 <b>SC-1172b</b> • Tooth: 32 *	Standard * Reverse fitted	<b>SC-1183</b> • Tooth: 33 <b>SC-1184</b> • Tooth: 34 <b>SC-1185</b> • Tooth: 35 <b>NEW</b> <b>SC-1186</b> • Tooth: 36 <b>NEW</b>
For 25° motor mounts. Screw: M2 • ø 17 mm			Screw: M2 • ø 16,5 mm Screw: M2 • ø 16,75 mm Screw: M2 • ø 17 mm



### SideWinder Procomp RS



	<b>SC-1151</b> • Tooth: 31 <b>NEW</b> <b>SC-1152</b> • Tooth: 32 <b>SC-1153</b> • Tooth: 33 <b>SC-1154</b> • Tooth: 34 <b>SC-1155</b> • Tooth: 35 <b>SC-1156</b> • Tooth: 36 <b>NEW</b>
	<b>SC-1143</b> • Tooth: 33 <b>SC-1144</b> • Tooth: 34 <b>SC-1145</b> • Tooth: 35 <b>SC-1146</b> • Tooth: 36 <b>SC-1147</b> • Tooth: 37
	Screw: M2 • ø 17,5 mm Screw: M2 • ø 18,5 mm

### Axle accessories

	<b>SC-1125</b> Axle solid stabilizer for 3/32" axles and NSR chassis		<b>SC-1125b</b> Axle solid stabilizer for 3/32" axles and Ninco chassis
	<b>SC-1124</b> 3/32" Axle stopper light and anodized. M2 Screw.		

	Tech 1 • 20.000 r.p.m.	Tech 2 • 25.000 r.p.m.	Tech 3 • 30.000 r.p.m.	Outlaw
<p>Motor S-CAN Tested at 12V Size: 25x20x15mm Double shaft Plastic endbell 2 mm Axle</p>	 <p>SC-08b 4,5 gr 0,21 Amp 216 gr x cm</p>	 <p>SC-09 4,5 gr 0,26 Amp 170 gr x cm</p>	 <p>SC-10b 5,5 gr 0,32 Amp 206 gr x cm</p>	 <p>36.000 r.p.m. SC-07 8 gr 0,40 Amp 190 gr x cm</p>
<p>Motor LONG-CAN Tested at 12V Size: 32,1x20,2x15,3mm Sealed endbell 2 mm Axle</p>	 <p>SC-11b 5 gr 0,18 Amp 205 gr x cm</p>	<p>COMING EARLY 2012</p>  <p>SC-12 8 gr 0,25 Amp 280 gr x cm</p>	 <p>SC-13 9,5 gr 0,32 Amp 330 gr x cm</p>	 <p>33.000 r.p.m. SC-04 4,5 gr 0,54 Amp 360 gr x cm</p>
<p>Motor SHORT-CAN Tested at 12V Size: 25x20x15mm Sealed endbell 2 mm Axle</p>	 <p>SC-14b 0,5 gr 0,20 Amp 205 gr x cm</p>	 <p>SC-15b 0,5 gr 0,18 Amp 225 gr x cm</p>	<p>COMING EARLY 2012</p>  <p>SC-16 0,5 gr 0,35 Amp 260 gr x cm</p>	 <p>30.000 r.p.m. SC-05 0,5 gr 0,42 Amp 280 gr x cm</p>
<p>Motor SLIM-CAN Tested at 12V Size: 26,9x15,5x12mm Sealed endbell 1,5 mm Axle</p>		 <p>SC-18 4,5 gr 0,16 Amp 90 gr x cm</p>	 <p>SC-19 4 gr 0,22 Amp 100 gr x cm</p>	 <p>38.000 r.p.m. SC-22 4,5 gr 0,28 Amp 120 gr x cm</p>

HOMESSET	HOMESSET	BB SERIES Bearings	BB SERIES Bearings
 <p>Motor S-CAN Tested at 12V. Size: 25 x 20 x 15 mm Double Shaft Fits Fly, Ninco, MRRC, Scalextric, Proslot</p> <p>SC-24 gr 10.000 r.p.m. 0,08 Amp 100 gr x cm</p>	 <p>Motor SLIM-CAN Tested at 12V. Size: 26.9x15.5x12 mm Sealed Endbell Fits Scalextric Moto GP, Scalextric LMP, MRRC Sebring chassis</p> <p>SC-23 gr 10.000 r.p.m. 0,06 Amp 45 gr x cm</p>	 <p>Motor S-CAN Tested at 12V. Size: 25 x 20 x 15 mm Double Shaft - mm Axle.</p> <p>SC-20 9 gr 20.000 r.p.m. 0,20 Amp 170 gr x cm</p>	 <p>Motor LARGE-CAN Tested at 12V. Size: 32,1 x 20,2 x 15,3 mm</p> <p>SC-21 9 gr 20.000 r.p.m. 0,20 Amp 250 gr x cm</p>

Sprinter	Endurance	Outlaw
 <p>Motor LONG-CAN Tested at 12V. Size: 32,1 x 20,2 x 15,3 mm Sealed endbell - 2 mm Axle.</p> <p>SC-25 14,5 gr 21.000 r.p.m. 0,21 Amp 320 gr x cm</p>	 <p>Motor LONG-CAN Tested at 12V. Size: 32,1 x 20,3 x 15,3 mm</p> <p>SC-26 4 gr 22.000 r.p.m. 0,20 Amp 320 gr x cm</p>	 <p>Motor S-CAN Tested at 12V. Size: 25x20x15mm Endbell drive - 2 mm Axle.</p> <p>SC-06 5,5 gr 30.000 r.p.m. 0,30 Amp 185 gr/160 cm</p>

All magnetic effect have been measured with MSC MPM units.



**Self sticking ballast**



Provided with convenient easy-peel high strength adhesive layer



Reference	Description
SC-1510	Special self sticking ballast 100 x 50 x 1,5 mm
SC-1511	Special self sticking ballast 100 x 50 x 1 mm
SC-1512	Special self sticking ballast 100 x 50 x 0,5 mm <b>NEW</b>
SC-1513	Special self sticking ballast 100 x 50 x 2 mm <b>NEW</b>

**Professional liquids**



**SC-5303**  
White magic grease special for gears



**SC-5302**  
Speed oil special for bearings and motors



**SC-5300**  
Sponge/Rubber tyre cleaner.



**SC-5301**  
Slotgrip Sponge/Rubber tyre cleaner.

**Guides & accessories**

<p><b>SC-1603</b> Universal guide 7,9 mm blade with adjustable spacers</p> <p><b>SC-1604</b> Universal guide 6,8 mm blade with adjustable spacers</p>	<p><b>SC-1605</b> Clip In Home Guide 7 mm</p>	<p><b>SC-1606</b> Clip In Home Guide 7 mm with active suspension</p>

<p><b>SC-1608</b> Italian cars guide 7mm blade with adjustable spacers</p> <p><b>SC-1607</b> Italian cars guide 8,3 mm blade with adjustable spacers</p>	<p><b>SC-1620</b> Clip-in home Rally Guide 7 mm</p>	<p><b>SC-1621</b> Clip-in home Rally Guide 7 mm. with active suspension</p>

	<p><b>SC-1610</b> Red silicone wire 1 m length. Diameter: 1,3 mm Oxygen Free (0%)</p>		<p><b>SC-1611</b> Black silicone wire 1 m length. Diameter: 1,3 mm Oxygen Free (0%)</p>		<p><b>SC-1625</b> Clear Orange silicone wire 1 m length. Diameter: 0,9 mm Oxygen Free (0%)</p>
--	---	--	---	--	--

	<p><b>SC-1616</b> Guide terminals for 1/32 slot cars</p>		<p><b>SC-1612</b> Universal soft braids</p> <p><b>SC-1613</b> Universal standard braids</p>
--	--	--	---

## Pinions M50 for 2mm motor shaft

2 units each pack

Aluminium	
	<b>SC-1027</b> Diameter: 4,5 Teeth: 7
	<b>SC-1028</b> Diameter: 5,40 Teeth: 8
	<b>SC-1029</b> Diameter: 5,80 Teeth: 9
	<b>SC-1030</b> Diameter: 6,35 Teeth: 10
	<b>SC-1031</b> Diameter: 6,75 Teeth: 11
	<b>SC-1032</b> Diameter: 7,25 Teeth: 12
	<b>SC-1033</b> Diameter: 7,75 Teeth: 13
	<b>SC-1034</b> Diameter: 8,25 Teeth: 14
	<b>SC-1035</b> Diameter: 8,70 Teeth: 15

Steel	
	<b>SC-1127</b> Diameter: 4,5 Teeth: 7
	<b>SC-1128</b> Diameter: 5,40 Teeth: 8
	<b>SC-1129</b> Diameter: 5,80 Teeth: 9
	<b>SC-1130</b> Diameter: 6,35 Teeth: 10
	<b>SC-1131</b> Diameter: 6,75 Teeth: 11
	<b>SC-1132</b> Diameter: 7,25 Teeth: 12
	<b>SC-1133</b> Diameter: 7,75 Teeth: 13
	<b>SC-1134</b> Diameter: 8,25 Teeth: 14
	<b>SC-1135</b> Diameter: 8,70 Teeth: 15

Brass	
	<b>SC-1190</b> Diameter: 4,5 Teeth: 7
	<b>SC-1191</b> Diameter: 5,40 Teeth: 8
	<b>SC-1192</b> Diameter: 5,80 Teeth: 9
	<b>SC-1193</b> Diameter: 6,35 Teeth: 10
	<b>SC-1194</b> Diameter: 6,75 Teeth: 11
	<b>SC-1195</b> Diameter: 7,25 Teeth: 12
	<b>SC-1196</b> Diameter: 7,75 Teeth: 13
	<b>SC-1197</b> Diameter: 8,25 Teeth: 14
	<b>SC-1198</b> Diameter: 8,70 Teeth: 15

## Plastic nylon press-on pinions



**SC-1005**  
Nylon M50 set Tooth ( 8 , 9 , 10,12 , 14 ).

## Axles

Ø (D)	Length (L)	STEEL Qty	HOLLOW Qty	CARBON Qty	TITANIUM Qty
3 / 32"	45 mm	SC-1209 (2)	SC-1201 (1)	SC-1220 (1)	
	50 mm	SC-1210 (2)	SC-1202 (1)	SC-1221(1)	SC-1230 (1)
	55 mm	SC-1211 (2)			SC-1231(1)
	60 mm	SC-1212 (2)			
	65 mm	SC-1213 (2)			
	70 mm	SC-1214 (2)			
3 mm	60 mm	SC-1240 (2)		SC-1262 (1)	
	65 mm	SC-1241 (2)		SC-1263 (1)	
	70 mm	SC-1242 (2)		SC-1264 (1)	
	75 mm	SC-1243 (2)		SC-1265 (1)	
3 mm	65 mm	SC-1241b	<b>• NEW •</b>	Specially for ceramic Ball Bearing superfine adjustment [SC-1335]	
	70 mm	SC-1242b	<b>• NEW •</b>		

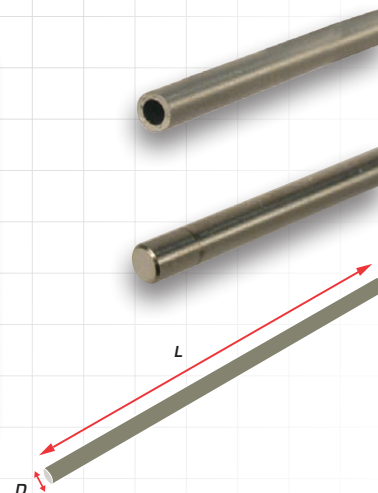

## Axle Accessories

2 units each pack

### Bronze and nylon bushing

	<b>SC-1354</b> Bronze 5 x 2mm Not flanged		<b>SC-1351</b> Bronze. 5mm x 3/32" Flanged.		<b>SC-1357</b> Bronze. 6mm x 3/32" Flanged.		<b>SC-1358</b> Bronze. 6mm x 3/32" Double flanged.
	<b>SC-1352b</b> Nylon 5mm x 3/32" Double flanged		<b>SC-1362b</b> Nylon 5mm x 3/32" Triple flanged		<b>SC-1325</b> Nylon 5mm x 3/32" Double flanged Bronze insert		

### High quality ceramic ball bearing

	<b>SC-1328</b> 5mm x 3/32" Open wall. Flanged. For 3/32" Axle		<b>SC-1335</b> 6 x 3mm Open wall. Flanged. For 3mm Axle
--	---	---	---

### High quality ball bearing

	<b>SC-1334</b> 6,35mm x 1/8" Flanged. For 1/8"mm Axle
--	--

### High quality steel ball bearing 3/32" Axle

	<b>SC-1319</b> 4,75mm x 3/32" Not flanged.		<b>SC-1320</b> 4,75mm x 3/32". Flanged.		<b>SC-1323</b> 5mm x 3/32" Double flanged. Width 2mm
	<b>SC-1321</b> 5mm x 3/32" Not flanged.		<b>SC-1322</b> 5mm x 3/32" Flanged. Width 2,5mm		<b>SC-1324</b> 5mm x 3/32" Double flanged. Width 1,7mm.
	<b>SC-1332</b> 6mm x 3/32" Not flanged. Width 2,6mm.		<b>SC-1329</b> 6mm x 3/32". Flanged.		

### High quality steel ball bearing 3mm Axle

	<b>SC-1330</b> 6 x 3mm Not flanged.		<b>SC-1331</b> 6 x 3mm Flanged.		<b>SC-1333</b> 6 x 3mm. Open wall. Flanged.
---	---	---	---------------------------------------	---	---

## Screws and nuts

	<b>SC-5100</b> Selflocking nuts M2 x 4,5 mm (10 units)		<b>SC-5101</b> M2 inox hardened nuts (10 units)		<b>SC-5119</b> Assorted screw set (10 units)
	<b>SC-5118</b> Selflocking nuts M2 x 4 mm (10 units)		<b>SC-5102</b> M2 nylon nuts (10 units)		<b>SC-5120</b> Countersunk M2 Titanium screws (20 units) 4 x M2x4 • M2 x 6 • M2 x 8 M2 x 10 • M2 x 12
	<b>SC-5104</b> Phillips steel screw (10 units)		<b>SC-5105</b> Philips steel screw conic head M2 x 8mm (10 units)		<b>SC-5121</b> Flat M2 Titanium screws (20 units) 4 x M2x2 • M2x4 • M2x6 M2x8 • M2x10
	<b>SC-5117</b> Titanium allen screw M2 x 6mm (10 units)		<b>SC-5109</b> Allen screw M2x4mm (10 units)		<b>SC-5122</b> Half thread M2 Titanium screws (6 units) 2 x M2x8 • M2 x 10 M2 x 12
	<b>SC-5103</b> Inox M2 self blocking spacers (10 units)		<b>SC-5110</b> Steel allen screw M2 x 6mm (10 u.)		
			<b>SC-5111</b> Allen inox screw M2 x 6mm Hubs/Gears (10 units)		
			<b>SC-5112</b> Allen inox screw M3 x 3mm Hubs/Gears (10 units)		
			<b>SC-5106</b> Flat nylon screw M2 x 10mm (10 units)		
			<b>SC-5107</b> Flat nylon screw M2x16mm (10 units)		

## SC-5040 Tyre trueing machine

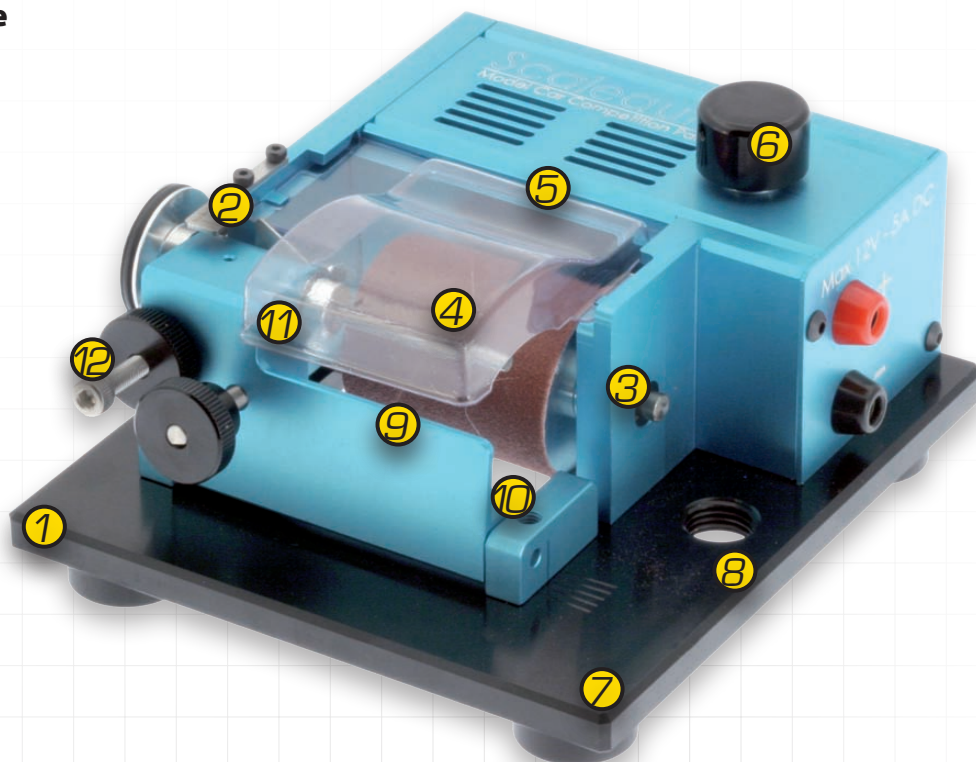

1. Complete vacuum box for dirt storage and protection.
2. Optical sanding measure view.
3. High quality ball bearings.
4. Allow to do 1 or 2 tyres at the same time for a perfect pair of competition set of tyres. Easy to exchange drum with different grain abrasive rolls.
5. Smooth 5 pole motor.
6. Preassembled electronic speed regulator. Only needs 3 Amp to work.
7. Anodized Aluminium CNC machined design.
8. Vacuum Cleaner Fixing Hole.
9. Up to 30 mm diameter tyres allowed.
10. Easy to disassemble for adjusting and replacing sanding drums, belts and cleaning.
11. For all types of available axles (3mm, 3/32" and 2,5mm).
12. Maximum sanding stopper.



SC-5040f Vacuum connector



SC-5040G Aluminium core drum



Reference	Description
SC-5040b	Abrasive roll 80 grid
SC-5040c	Abrasive roll 120 grid
SC-5040d	Abrasive roll 150 grid
SC-5040e	Abrasive roll 180 grid
SC-5040h	Abrasive roll 400 grid

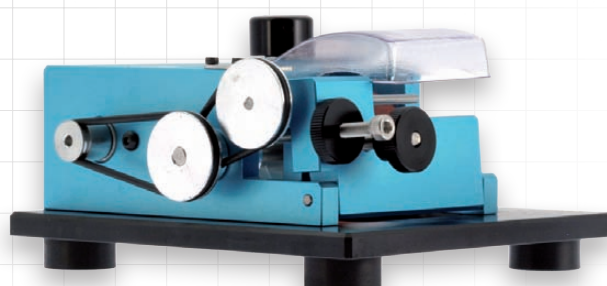
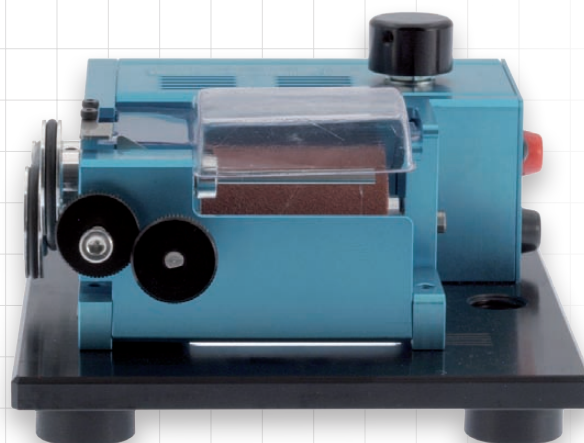

## Chassis ground clearance tools

Reference	Description
SC-5003	Tech tool for chassis ground clearance 1mm
SC-5004	Tech tool for chassis ground clearance 1,3mm
SC-5005	Tech tool for chassis ground clearance 2mm
SC-5006	Tech tool for chassis ground clearance 1mm / 1,2 mm
SC-5005	Tech tool for chassis ground clearance 1,3mm / 1,5mm



SC-5043 Ground clearance tech tool



SC-MK001 Scaleauto textile banners for track cover. 80cm height. Sold in 50m rolls.

## Acrylic car shelves



SC-5056  
1/32 acrylic car shelf for 2 cars  
SC-5057  
1/24 acrylic car shelf for 2 cars

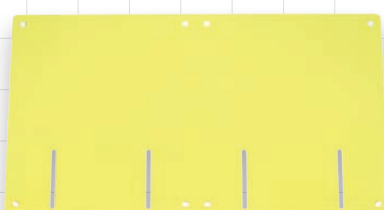

SC-5058  
Extension base for 4 cars for 1/32  
SC-5061  
Extension base for 4 cars for 1/24



SC-5059  
Extension base for 6 cars for 1/32  
SC-5062  
Extension base for 6 cars for 1/24



SC-5060  
Extension base for 8 cars for 1/32  
SC-5063  
Extension base for 8 cars for 1/24



## Excellent for professional race organization

1. Convenient transportation platforms for race organization and as storage solution.
2. Keeps your car tyres away from dirt and avoids direct hand manipulation.
3. Expandable from two to eight lanes.
4. Available in two sizes: for 1/32 and 1/24 scale cars.



**SC-5050**

Aluminium modular Slot Box (37x25x80 cm) with wheels

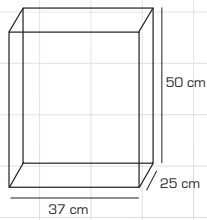
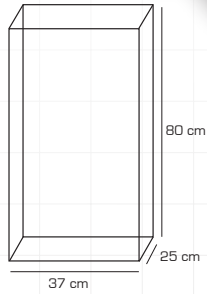

**SC-5051**

Aluminium reduced size Slot Box (37x25x50 cm).

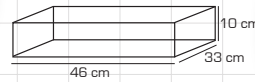

**SC-5052**

Aluminium mini size Slot Box (46x33x10 cm).

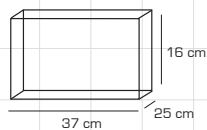

**SC-5053**

Aluminium Slot Box car transport (37x25x16cm).

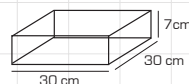

**SC-5054**

Aluminium controller box (30x30x7cm).

## Box Containers

Used to store your bolts and nuts, tires, braids and small pieces. Join them together to get a larger independent storage boxes to fit your needs.



SC-5055a



SC-5055b



SC-5055c

Reference	Description
SC-5055a	Large piece box container 70x70mm (4 pieces)
SC-5055b	Medium piece box container, 70x30mm (6 pieces)
SC-5055c	Small piece box container, 21x30mm (10 pieces)
SC-5055d	Combitkit container, 3 sizes containers, fully combinable to store all your spare parts correctly (2+2+6)



Adjustable torque  
**ProDyno**

Tools	ProTool	ProDyno
	<b>SC-5030</b> ProTool allen 0,95 mm with blue aluminium handle	<b>SC-5044</b> ProDyno wrench allen 0'95 mm
	<b>SC-5038</b> ProTool Allen 1,3 mm with blue aluminium handle	<b>SC-5045</b> ProDyno wrench allen 1,3 mm
	<b>SC-5031</b> ProTool allen 1,5 mm with blue aluminium handle	<b>SC-5046</b> ProDyno wrench allen 1,5 mm
	<b>SC-5032</b> ProTool allen 2 mm with blue aluminium handle	
	<b>SC-5033</b> ProTool Phillips screwdriver with blue aluminium handle	
	<b>SC-5034</b> ProTool M4 nut with blue aluminium handle	
	<b>SC-5035</b> ProTool M4,5 nut with blue aluminium handle	



- SC-5036**  
M1,5 allen bit spare for Pro Tool.
- SC-5037**  
M0,95 allen bit spare for Pro Tool.
- SC-5041**  
M1,3 allen bit spare for Pro Tool.
- SC-5047**  
M0.95 allen bit spare for Pro Tool.
- SC-5048**  
M1,3 allen bit spare for Pro Tool.
- SC-5049**  
M1,5 allen bit spare for Pro Tool.

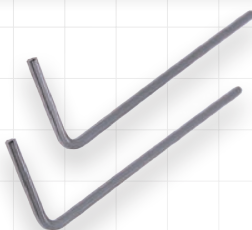

- SC-5024**  
M1,5 economic allen.
- SC-5025**  
M2,5 economic allen.
- SC-5026**  
M0,95 economic allen.

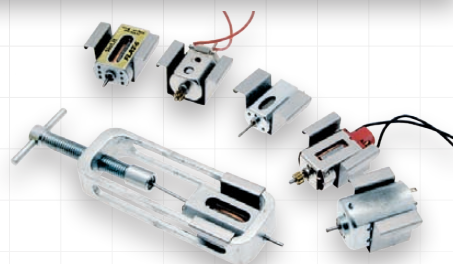

**SC-5000b**  
Pinion press for all can motors.



**SC-5001b**  
Mini pinion puller.



**IBB** | Auto  
Racing

**IBB Auto Racing, S.L.**  
C/ La Masia, 28  
08711 Odena (Barcelona) -Spain-  
Tel.+34 93 803 08 80 Fax.+34 93 805 50 57  
email: [info@ibbautoracing.com](mailto:info@ibbautoracing.com)  
[www.ibbautoracing.com](http://www.ibbautoracing.com)